

# Unicon

## Type CXE/AVC (E)

### Universal module with timer function

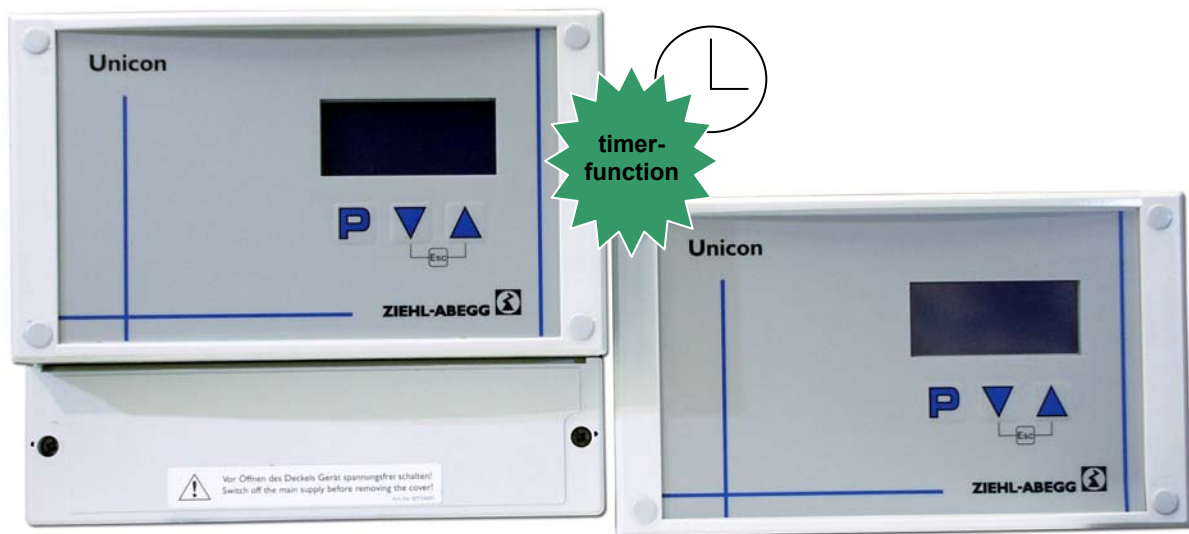

Manufacturer: ZIEHL-ABEGG AG  
Heinz-Ziehl-Straße  
D-74653 Künzelsau  
Telefon: +49 (0) 7940 16-0  
Telefax: +49 (0) 7940 16-504  
e-mail: [info@ziehl-abegg.de](mailto:info@ziehl-abegg.de)  
internet: <http://www.ziehl-abegg.de>

Software D 1185A03 Part.No. 00162609 from version 1.07

**Contents**

|  |           |
|--|-----------|
| <b>1. General</b> .....  | <b>4</b>  |
| <b>2. Safety measures</b> .....  | <b>4</b>  |
| <b>3. General description</b> .....  | <b>5</b>  |
| 3.1 Scope of applications .....  | 5         |
| 3.2 Technical data .....   | 5         |
| 3.3 Versions Unicon .....  | 5         |
| <b>4. Installation</b> .....   | <b>6</b>  |
| 4.1 Wall-mounting, installation in a switching cabinet.....  | 6         |
| 4.2 Outdoor installation .....   | 6         |
| 4.3 Installation location for agriculture.....   | 6         |
| 4.4 Temperature influences during commissioning.....   | 6         |
| 4.5 Potential at control voltage connections.....  | 6         |
| <b>5. Electrical connections</b> .....   | <b>7</b>  |
| 5.1 Mains connection .....   | 7         |
| 5.2 Signal cable (sensor cable).....   | 7         |
| 5.3 Signal connection to analog inputs (Analog IN1, Analog IN2, ..).....                               | 7         |
| 5.4 Output voltage 0-10 V (Analog OUT1 und Analog OUT2).....   | 7         |
| 5.5 Voltage supply for external devices (+24 V, GND) .....   | 7         |
| 5.6 Relay outputs (K1, K2) .....   | 7         |
| 5.7 Digital inputs (D1 .. D5) .....  | 8         |
| 5.8 Connection RS-485 interface for MODBUS .....   | 8         |
| <b>6. Controls</b> .....   | <b>8</b>  |
| 6.1 Multipurpose LC display .....  | 8         |
| <b>7. Connection terminals depending on input signal</b> .....   | <b>9</b>  |
| 7.1 External Setpoint / External speed setting in manual operation .....                               | 9         |
| <b>8. Mode selection</b> .....   | <b>10</b> |
| 8.1 Selection of the mode of operation .....   | 10        |
| 8.2 Menu operation .....   | 11        |
| 8.3 Setting Mode, menu language and motorsetup .....   | 12        |
| <b>9. Programming</b> .....  | <b>13</b> |
| 9.1 Speed controller <b>1.01</b> .....   | 13        |
| 9.1.1 Basic setting <b>1.01</b> .....  | 13        |
| 9.1.2 Setting for operation <b>1.01</b> .....  | 13        |
| 9.1.3 Menu speed controller <b>1.01</b> .....  | 14        |
| 9.2 Temperature control <b>2.01</b> .. <b>2.05</b> .....   | 15        |
| 9.2.1 Basic setting <b>2.01</b> .. <b>2.05</b> .....   | 15        |
| 9.2.2 Settings for operation modes <b>2.01</b> .. <b>2.05</b> .....                                    | 16        |
| 9.2.3 Functional diagrams temperature control .....  | 17        |
| 9.2.4 For mode <b>2.03</b> temperature controller with additional functions: Signal output 0-10 V..... | 18        |
| 9.2.6 For mode <b>2.03</b> Relay output for temperature monitoring.....                                | 20        |
| 9.3 Pressure control for condensers refrigeration <b>3.01</b> .. <b>3.04</b> .....                     | 23        |
| 9.3.1 Basic setting <b>3.01</b> <b>3.02</b> .....  | 23        |
| 9.3.2 Setting for operation <b>3.01</b> .. <b>3.04</b> .....   | 24        |
| 9.3.3 Menu for pressure control refrigeration <b>3.01</b> .. <b>3.04</b> .....                         | 25        |
| 9.4 Pressure control for ventilation systems <b>4.01</b> .. <b>4.03</b> .....                          | 27        |
| 9.4.1 Basic setting <b>4.01</b> .. <b>4.03</b> .....   | 27        |
| 9.4.2 Setting for operation modes <b>4.01</b> .. <b>4.03</b> .....                                     | 28        |
| 9.4.3 Menu for pressure control airconditioning <b>4.01</b> .. <b>4.02</b> .....                       | 29        |
| 9.5 Volume control <b>5.01</b> , <b>5.02</b> .....   | 31        |
| 9.5.1 Basic setting <b>5.01</b> , <b>5.02</b> .....  | 31        |
| 9.5.2 Setting for operation modes <b>5.01</b> and <b>5.02</b> .....                                    | 32        |

9.6 Air velocity control **6.01** ..... 35

    9.6.1 Basic setting **6.01** ..... 35

    9.6.2 Settings for operation modes **6.01** ..... 35

    9.6.3 Menu for air velocity control **6.01** ..... 36

**10. Menu group Start** ..... **38**

**11. Menu group Info** ..... **38**

**12. Controller Setup** ..... **39**

    12.1 PIN Protection ..... 39

    12.2 Set protection ..... 39

    12.3 Save user settings ..... 39

    12.4 Sensor Alarm ON / OFF ..... 40

    12.5 Limit ..... 40

    12.6 Minimum speed cut off ..... 40

    12.7 Second Group ..... 41

    12.8 Reverse action of the control function (actual Value>Set = n+) ..... 41

    12.9 Controller configuration (controller type) and controller action ) ..... 42

**13. IO Setup** ..... **43**

    13.1 Analog Output A (Analog OUT 1) ..... 43

        13.1.1 Function analog output A (Analog OUT 1) ..... 43

        13.1.2 Adjustment analog output A1 und A2 ..... 44

    13.2 Functional overview of digital inputs D1 ... D5 ..... 45

        13.2.1 Enable ON / OFF **Funktion 1D** ..... 46

        13.2.2 External fault **Funktion 2D** ..... 46

        13.2.3 Limit ON / OFF **Funktion 3D** ..... 47

        13.2.4 Switch over E1 / E2 **Funktion 4D** ..... 47

        13.2.5 Set Intern 1 / Set Intern 2 or. Setpoint 1/2 **Funktion 5D** ..... 48

        13.2.6 Intern / Extern **Funktion 6D** ..... 49

        13.2.7 Automatic control / speed manual internal (Menu Speed maunal) **Funktion 7D** ..... 50

        13.2.8 Reverse action of control function actual value>Set = n+ or actual value>Set = n- **Funktion 8D** ..... 50

    13.3 Inverting analog inputs E1 and E2 ..... 51

    13.4 Function and inverting for relay outputs K1 and K2 ..... 52

    13.5 Network for several devices by MODBUS ..... 53

        13.5.1 MODBUS - RTU (Remote terminal unit) ..... 53

        13.5.2 External display ..... 53

        13.5.3 Reading and writing parameters ..... 53

**14. Limits** ..... **54**

    14.1 Limit indication depending on modulation ..... 54

    14.2 Limit indication depending on setting or sensor signal ..... 55

    14.3 Limit indication depending on offset to Setpoint ..... 56

**15. Timer (timer)** ..... **57**

    15.1 Setting the time and date ..... 57

    15.2 Automatic summer/winter time ..... 57

    15.3 Timer function ..... 57

    15.4 Enter switching times ..... 58

**16. Diagnostics menu** ..... **59**

**17. Enclosure** ..... **60**

    17.1 Connection diagram ..... 60

    17.2 Dimension sheet ..... 61

**18. Events** ..... **62**

**19. Messages and trouble shooting** ..... **62**

**20. Index** ..... **63**

**1. General**

**Before installation and start-up, read this manual carefully to ensure a correct use.**

**Attention! Hazardous area!**



**Danger owing to electric current or voltage!!**



**Important information!**



- The copyright for these operating instructions remains to ZIEHL-ABEGG AG, Künzelsau.
- The device is constructed in accordance with the current state of technology and the recognised safety regulations. Nevertheless, use of the device is associated with dangers which may cause death or injury to users or third parties as well as damage to the system and other objects.
- The device is intended exclusively for the tasks listed in the order confirmation. Any other or extraordinary uses of the device (unless previously agreed by contract) are considered contrary to regulations. The manufacturer is not liable for damages resulting from incorrect use. The operating company alone bears the risk.
- To allow for future developments, construction methods and technical data given are subject to alteration. We do not accept any liability for possible errors or omissions in the information contained in data, illustrations or drawings provided.
- The controllers are packed ex factory to suit the transport method previously agreed. Always use the original packaging materials when transporting the controller. When transporting by hand, ensure that personnel possess the strength required to lift and carry the device. Avoid shocks and impacts to the device. Check the packaging and controller for damage.
- Store the controller in its original packaging in a dry and weather-proof room. The device must not be exposed to extreme heat and low temperatures.

**2. Safety measures**

**In the case of a malfunction or a failure of the equipment check all functions with alarms in order to prevent injury to persons or property. Note possibility of back-up operation.**

**If used in intensive animal environments, any malfunctions in the air supply must be detected as soon as possible to prevent the development of a life-threatening situation for the animals. The design and installation of the system must comply with local regulations and directives. In Germany these include DIN VDE 0100, the animal protection and the keeping of working animals ordinance and the pig-keeping ordinance etc.**

**Also note the instructions of AEL, DLG, VdS.**

- Apart from the operating instructions and the obligatory regulations to be followed by users relating to accident prevention, the recognised technical regulations must also be observed (safety and branch-related work as per UVV, VBG, VDE, etc.).
- These devices are potentially dangerous if they are used incorrectly by untrained personnel or are not implemented according to their specified use.
- **Work on electric components/modules may only be carried out by trained electricians in accordance with electro-technical regulations (e.g. EN 60204, DIN VDE 0100/0113/0160).**
- The contractor or owner must also ensure that the electric systems and equipment are operated and maintained in accordance with electro-technical regulations. The owner is obliged to ensure that the device are operated in perfect working order only.
- **It is forbidden to carry out work on electrically live parts. The rating given in the enclosure for the device when open is IP00! It is possible to inadvertently touch components carrying hazardous voltages!**
- During operation, the device must be closed or installed in a control cabinet.
- Fuses may only be replaced by new ones and must not be repaired or bypassed. The data for the maximum line fuse are to be considered absolutely (☞ Technical data). Use only fuses specified in schematic diagrams.
- The safe isolation from the supply must be checked using a two-pole voltage detector.
- Any faults detected in the electric system/modules/operating equipment must be corrected immediately. If these faults are not corrected, the device/system is potentially very dangerous. The device/system must therefore not be operated when it is faulty.

### 3. General description

#### 3.1 Scope of applications

##### Universal controller for clean room, refrigeration and air conditioning

Controlled 0-10 V „A1“ (Analog OUT 1) output e.g. for electronic speed controllers of fans

#### 3.2 Technical data

| Type     | Part.No | line voltage                                | internal device fuse                      | Weight  |
|----------|---------|---|---|---------|
| CXE/AVC  | 320006  | 1~ 110 .. 277 V (-15 % bis +10 %), 50/60 Hz | T 400 mA (5x20 mm)<br>Art.Nr. 00153002    | 1.05 kg |
| CXE/AVCE | 320008  |   |   | 0.85 kg |
| CXE/AVC  | 320007  | 2~ 208 .. 415V (-15 % bis +10 %), 50/60 Hz  | T 400 mA (6,3 x 32mm)<br>Art.Nr. 00153840 | 1.05 kg |

- Input resistance for sensor or signal set for the rotational speed:  
- for 0-10 V input:  $R_i > 100 \text{ k}\Omega$  / - bei Eingang 4-20 mA:  $R_i = 100 \Omega$
- Voltage supply e.g. for sensors +24 V  $\pm 20 \%$ ,  $I_{\text{max}}$  120 mA (for connection to an external AXG terminal minus ca. 50 mA)
- Output (0-) 10 V,  $I_{\text{max}}$  10 mA (short-circuit-proof)
- Heat dissipation approx. 6.5 W
- Max. line fuse 10 A
- The clock is buffered and has a 2-3 day reserve
- Max. permissible ambient temperature 40° C
- Min. permissible ambient temperature 0° C (if mains voltage is not switched off up to -20°C)
- Permissible rel. humidity 85 % no condensation
- Interference emission EN 61000-6-3
- Interference immunity EN 61000-6-2

#### 3.3 Versions Unicon

Type CXE/AVC Housing version IP54 for wall mounting

Type CXE/AVCE for panel mounting (IP54 mounted)

## 4. Installation

### 4.1 Wall-mounting, installation in a switching cabinet

- For CXE/AVC Housing version for wall mounting  
Assemble the device on a clean and stable base. Do not distort during assembly! Use the appropriate mounting devices for proper installation of the unit!
- For CXE/AVCE for panel mounting  
The installation cutout of the controller amounts to 206 x 118 mm (⌀ dimensions). Bring the controller into the installation cutout and hang up you the enclosed clamps laterally. Subsequently, you screw the threaded rods with a screwdriver against the housing.
- Do not mount equipment on vibrating base!
- Install the device away from transport routes. However, ensure however that the device is still easily accessible!
- Cable ducts must remain freely accessible!
- Protect the device from direct exposure to sunlight!
- The device is designed for vertical installation A reclined installation is only permissible after consultation with the manufacturer.

### 4.2 Outdoor installation

Outdoor installation is possible up to -20°C when the controller supply is not switched off.

Installation must be protected from the effects of weather as much as possible, including protection from direct sunlight!

### 4.3 Installation location for agriculture

In order to avoid damage caused by ammoniac vapours (NH<sub>3</sub>), the controller shall not be installed in the stable, but rather in an outhouse wherever possible.

### 4.4 Temperature influences during commissioning

Avoid condensation in the controller and hence functional faults attributable to condensation by storing the controller at room temperature!

### 4.5 Potential at control voltage connections

The control voltage connections (<50 V) relate to the joint GND potential (Exception: Relay contacts are potential free). There is a potential separation between the control voltage connections and the earthed conductor.

It must be ensured that the maximum external voltage at the control voltage connections cannot exceed 50V (between „GND“ terminals and „PE“ earthed conductor).

**5. Electrical connections**

**5.1 Mains connection**

Power from the mains is connected to terminals: PE, L1 and N. Here, it must be strictly observed that the mains voltage lies within the allowable tolerance specifications (☞ General description: Technical data and nameplate affixed to the side).

**The supply voltage has to correspond to DIN EN 50160!**

**5.2 Signal cable (sensor cable)**

Pay attention to sufficient distance from powerlines and motor wires to prevent interferences.

The control cables may not be longer than 30 m. Screened control cables must be used when the cable length is longer than 20 m. When using a screened cable, the screen must be connected to the protective conductor at one end, i.e. only at the control unit (as short and of as low an inductance as possible!).

**5.3 Signal connection to analog inputs (Analog IN1, Analog IN2, ..)**

The controller can work with 2 analog inputs, dependent on the type of signals must the appropriate terminals connected.

| Signal type                         | Connection terminals                     |
|-------------------------------------|--|
| Input 1 for Temperature sensor TF.. | 7 – 8 (to pay attention to no polarity)  |
| Input 2 for Temperature sensor TF.. | 9 - 10 (to pay attention to no polarity) |
| Input 1 for 4..20mA (0..20mA)       | 11 - *12 (with Two-wire-technology)      |
| Input 2 for 4..20mA (0..20mA)       | 13 - *14 (with Two-wire-technology)      |
| Input 1 for 0-10 V                  | 15 (+) - 16 (GND)                        |
| Input 2 for 0-10 V                  | 17 (+) - 18 (GND)                        |

Ensure correct polarity when connecting; a 24 V DC power supply is integrated for sensors.

\*For sensors in two-wire-technology (4-20 mA signal), the connection is made on the +24 V and terminals „11“ (Input 1) or “13“ (Input 2) the GND terminal is omitted.

For three wire technology connection to GND terminal is necessary (terminals 8,10,16,18)

The connection is independent of the programmed operating mode and from the sensor signal employed (☞ Presets of the selected operating mode).

**5.4 Output voltage 0-10 V (Analog OUT1 und Analog OUT2)**

Analog output 1 (Analog OUT 1) is pre-programmed control outpute.g. for controlling a speed controller for fans.

Connection to terminal „A“ - „GND“ = Analog OUT ( $I_{max}$  10 mA)

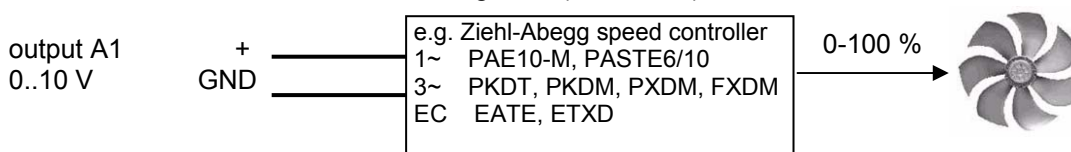

Analog output 2 (Analog OUT 2) is pre-programmed for constant voltage +10 V. E.g. supply for external potentiometer connection to terminals „A2“ - „GND“ = Analog OUT 2 ( $I_{max}$  10 mA)

Both 0-10 V analog outputs can be allocated with various functions (☞ IO Setup: Analog output A1 or A2).

**5.5 Voltage supply for external devices (+24 V, GND)**

A voltage supply is integrated for external devices, e.g., for a sensor.

Terminal +24 V Output voltage tolerance  $\pm 20\%$ .

Max. load current 120 mA (for connection to an external AXG terminal minus ca. 50 mA)

During an overload or short-circuit (24 V  $\leftrightarrow$  GND), the control voltage (and thus the controller) is disconnected (Multifuse). Automatic start after elimination of the cause of error

**5.6 Relay outputs (K1, K2)**

Various functions can be allocated to the relay outputs K1 and K2

(☞ IO Setup: Function and inversion of the relay outputs). Max. contact load 5A / 250 V AC

Connection of the floating contacts of relay K1 to the terminals 1, 2, 3

Connection of the floating contacts of relay K2 to the terminals 4, 5, 6

### 5.7 Digital inputs (D1 .. D5)

Various functions can be allocated to the digital inputs D1 ..D5  
 (☞ IO Setup: Functions summary of the digital inputs).  
 Activation via floating contacts (a low voltage of ca. 24 V DC is connected).



Never apply external voltage to the digital inputs!

### 5.8 Connection RS-485 interface for MODBUS

The device comes equipped via a RS-485 interface for networking via a MODBUS. The data connection lead is connected to **D+**, **D-** and **GND**.  
 The data connector spring-loaded contact is suitable for solid conductors of up to 0.5 mm<sup>2</sup> cross-section or 0.8 mm diameter. The stripped lead makes contact by itself upon insertion. The orange colored latch only needs to be pushed in the case of smaller cross-sections or when detaching the connections.



You must ensure correct connection; i.e. „**D+**“ must also be connected on the following devices to „**D+**“. The same applies to „**D-**“.  
In addition, a GND connection must be established, as dissimilar potential (over 10 V!) will lead to the destruction of the RS-485 interface (e.g. lightning).



The data line must be conducted from one device into the next. To do this, two connectors are available in each device. No other type of wiring is allowed.  
 Always use only two wires of one lead for the connection.  
 When using telephone flex with four cable cores, we recommend the following allocation:  
 „**D+**“ = red    „**D-**“ = black    „**GND**“ = white

#### Examples:

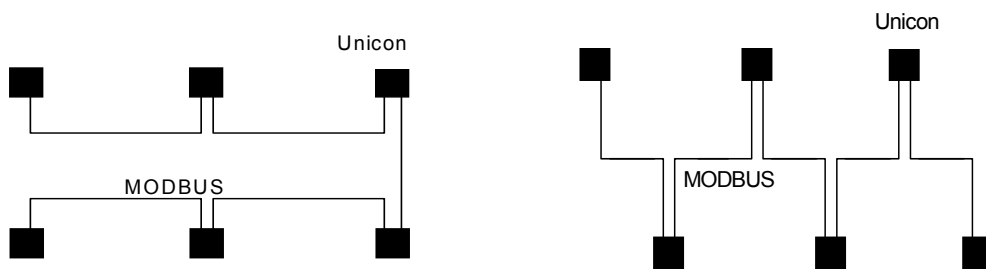

A maximum of 247 network users can be connected to the data bus .

## 6. Controls

### 6.1 Multipurpose LC display

- 1 Moon-Symbol for set point 2
- 2 Alarm-Symbol (fault indication)
- 3 Fire-Symbol (heating operation)
- 4 Antenna-Symbol (Remote-Control active)
- 5 STOP-Symbol (enable)
- 6 Bargraph (intern control output)
- 7 Text line 3 figures (display unit, etc.)
- 8 Text line 16 figures (display text menu.)
- 9 Numeric display 5 digit

- A** P-key (program key, open menu)
- B** arrow -down-key (Menu down, reduce value)
- C** arrow-up-key (Menu up, increase value)
- D** ESC-key combination (↑ + ↓)  
Escape, leave menu)

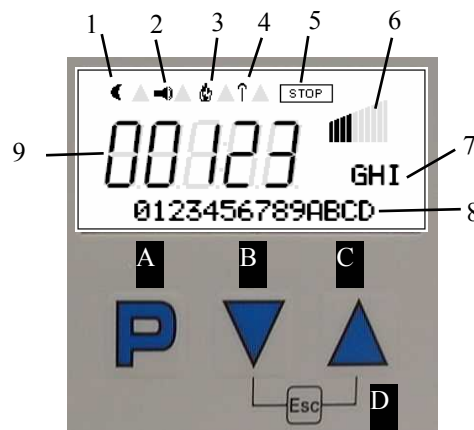



**7. Connection terminals depending on input signal** 

Dependet ont the type of signal must the appropriate terminals connected. If necessary configuration of sensors in menu „E1 Analog IN“ or. „E2 Analog IN“ .

**Analog IN 1 „E1“**

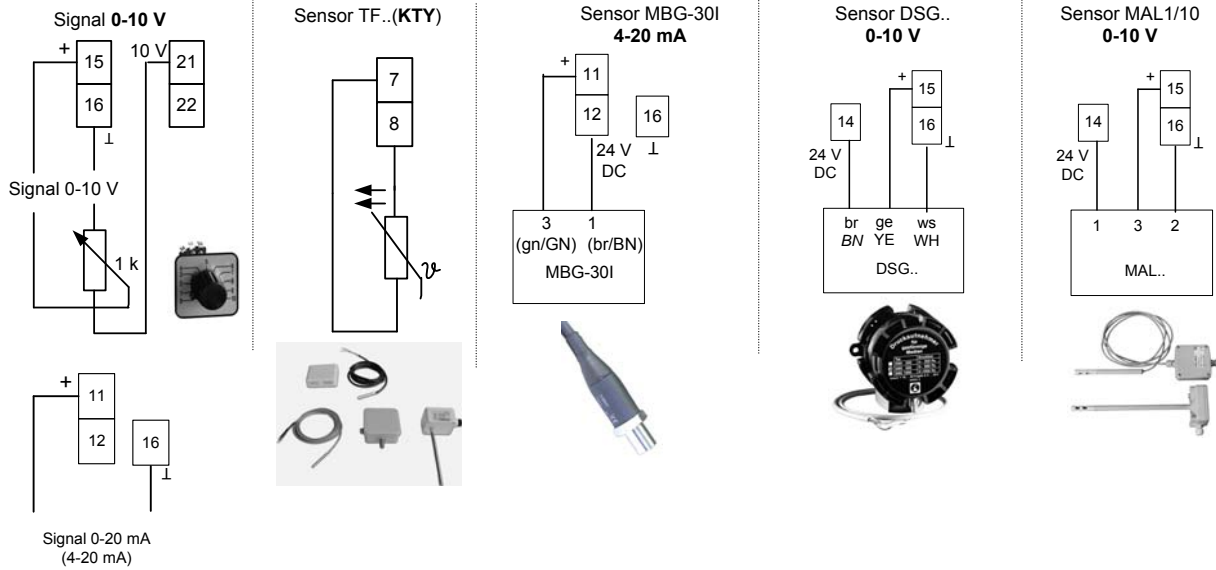

**Analog IN 2 „E2“ for modes with two sensors**

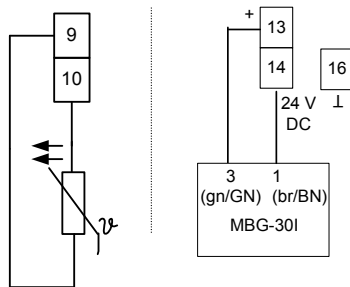

**7.1 External Setpoint / External speed setting in manual operation**

External Setpoint or external manual operation is possible by 0-10 V (0-20 mA, 4-20 mA) Signal at terminals „E2“ and „GND“. Place internal Jumper E2.1 and E2.2 for Analog IN 2 in correct position. Configuration in base setup. For Potentiometer Analog OUT 1 (terminal „A“) program to function 1A = +10 V (like factory setting IO Setup). If a second sensor is connected at input 2, external Setpoint or speed setting in manual operation is possible with additional modul “ZmodulB“ (input E3).

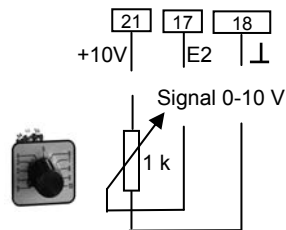

**External Setpoint** via external signal instead of „Setpoint 1“

The „External Setpoint“ function must be activated in base setup **1E** for **E2** function; The active external Setpoint value is displayed in the info menu group.



**External speed setting in manual operation**

The „External manual operation“ function must be activated in the basic settings **2E** for **E2** function. Switchover between settings on the device and external manual operation via the digital input or imer (IO Setup: Internal / External or timer).

**8. Mode selection****8.1 Selection of the mode of operation**

Simple installation is possible through the selection of the preprogrammed mode of operation. This determines the basic function of the device; factory setting 1.01 = speed controller (activation via 0-10 V signal).

The controller configuration is automatically carried out during selection of the application related mode of operation. The factory presets in accordance with the mode of operation are based on many years of experience, which is suitable for many applications. Under special circumstances, these can be individually adapted (☞ Controller Setup: Controller Configuration).

The purpose of the device is to reach and maintain the target values set. To accomplish this, the measured actual value (sensor value) is compared with the adjusted target value, and the controlled value (modulation) is deduced from this.

| Mode        | Signal or Sensor (input)                   | Function  |
|-------------|--|---|
| <b>1.01</b> | Signal 0-10 V (E1)                         | Speed controller, two step operation ( <b>factory setting</b> )                               |
| <b>2.01</b> | Sensor TF..(E1)                            | Temperature control airconditioning and refrigeration (preset set-point 20.0 °C, P-band 5K)   |
| <b>2.02</b> | Sensor TF..(E1)                            | Temperature control depending on outdoor temperature (preset set-point 5.0 °C, - P-band 20 K) |
| <b>2.03</b> | Sensor TF..(E1)                            | Temperature control with additional functions (shutter and heating)                           |
| <b>2.04</b> | 1x Sensor TF..(E1)<br>1x Sensor TF..(E2)   | Temperature control with two sensors, comparison or average                                   |
| <b>2.05</b> | 1x Sensor TF..(E1)<br>1x Sensor TF..(E2)   | Temperature control with two sensors differential temperature                                 |
| <b>3.01</b> | Sensor MBG.. (E1)                          | Pressure control condensers (refrigeration)   |
| <b>3.02</b> | Sensor MBG..(E1)                           | Pressure control for condensers with input for refrigerant                                    |
| <b>3.03</b> | 1x Sensor MBG..(E1)<br>1x Sensor MBG..(E2) | Pressure control for two circuit condensers   |
| <b>3.04</b> | 1x Sensor MBG..(E1)<br>1x Sensor MBG..(E2) | Pressure control for two circuit condensers with input for refrigerant                        |
| <b>4.01</b> | Sensor DSG..(E1)                           | Pressure control for ventilation systems  |
| <b>4.02</b> | 1x Sensor DSG..(E1)<br>1x Sensor TF..(E2)  | Pressure control depending on outdoor temperature   |
| <b>5.01</b> | Sensor DSG..(E1)                           | Volume control (constant) for ventilation systems   |
| <b>5.02</b> | 1x Sensor DSG..(E1)<br>1x Sensor TF..(E2)  | Volume control with setpoint depending on outdoor temperature                                 |
| <b>6.01</b> | Sensor MAL.. (E1)                          | Air velocity control  |

**8.2 Menu operation**

Display after turning on the mains voltage



Switch-over between **Fanlevel** and **Start** or **actual value** with the key shortcut for Escape (Esc = ↑ + ↓).

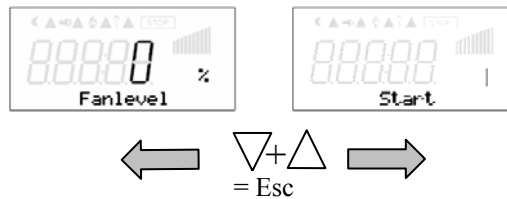

Example for mode **1.01** language English

One reaches the menu item **START** by pushing the **P** key.  
 One moves up and down within the menu group using the arrow keys.  
 One returns to the menu group using the **ESC** (↑ + ↓) shortcut keys.

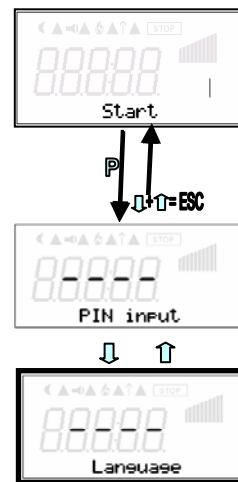

Selection of the menu group to the right through the down key, to the left through the up key.

The menu groups consist of one area for the user (user menu) and one area for installation (service).

The service area can be protected against unauthorized access by using a PIN.

In order to simplify the initial start-up operation, the service level is enabled at first (i.e., not protected by the **PIN 0010**, see Controller Setup, PIN protection = OFF).

If PIN protection is activated (ON), the service menu remains enabled after input of **PIN 0010** as long as one is pressing keys. If no keys are pressed for ca. 15 minutes, the PIN is automatically erased, i.e. the service level is blocked.

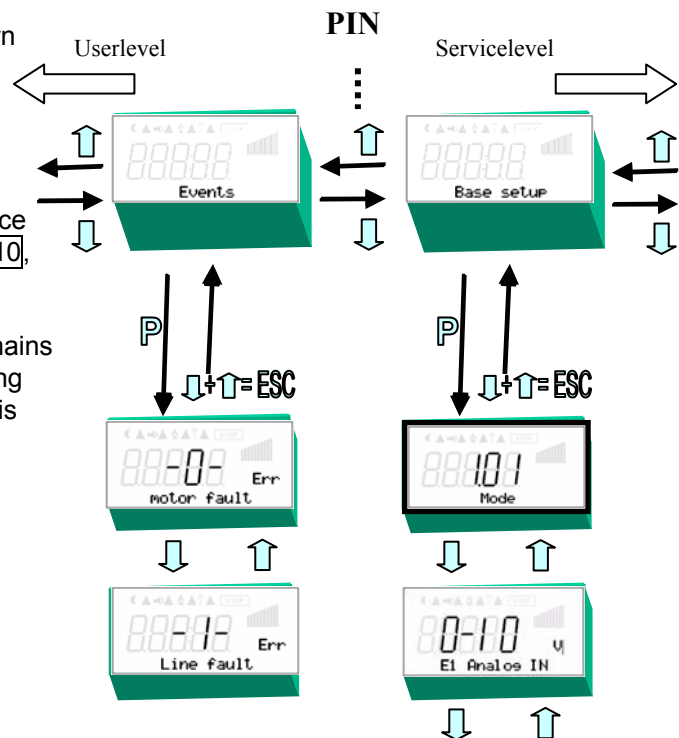

**After installation of the device has been carried out, PIN protection should be activated!**





**9. Programming**

**9.1 Speed controller 1.01**

**9.1.1 Basic setting 1.01**



↓P ↑ESC



Factory setting Mode **1.01**

↓ ↑

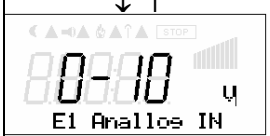

Factory setting 0-10 V  
Selection : 0-20 mA, 4-20 mA, Bus  
Inverting in IO Setup

↓ ↑



Analog input 2 „E2“ factory set at **OFF**

- For operation with a second signal and switch over via floating contact (☞ IO Setup) set to function **1E**.
- For operation with a second signal and automatic control at the higher level. Set E2 Funktion to **4E**.

↓ ↑



**9.1.2 Setting for operation 1.01**

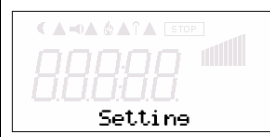

↓P ↑ESC

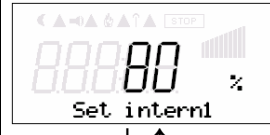

Manual speed setting  
Set Internal 1

↓ ↑

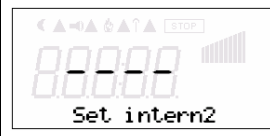

Set internal 2  
Switch over 1/2 by external contact

↓ ↑



Minimal speed  
0 - 100 %

↓ ↑

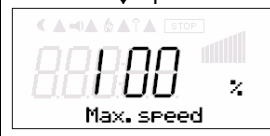

Maximal speed  
100% - Min.

↓ ↑

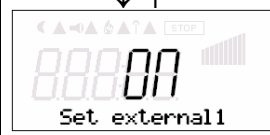

ON = (factory setting)  
speed setting by external signal  
OFF =  
Set internal 1

Diagram default signal and output voltage  
Idealized principle diagram

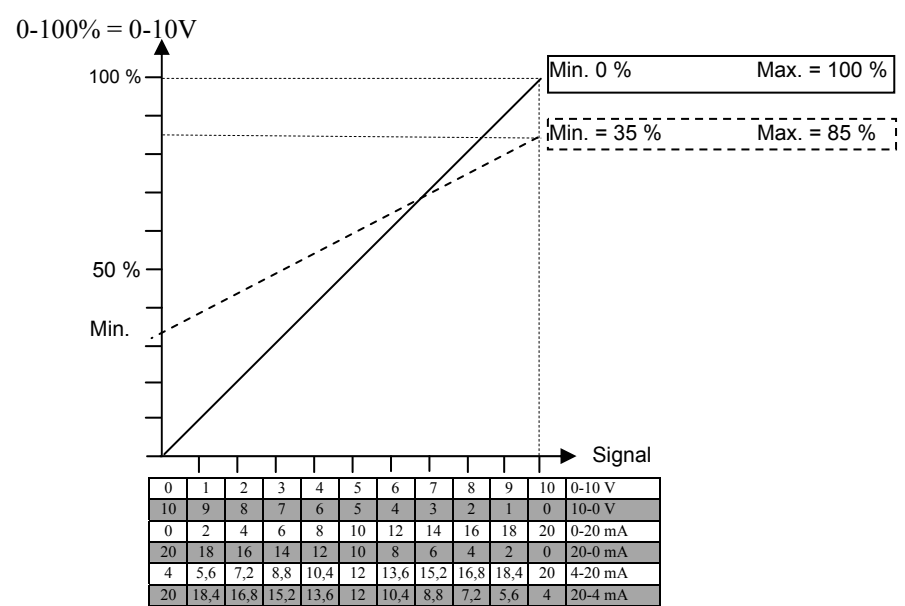

9.1.3 Menu speed controller **1.01**

|                         | Parameter              | Factory setting | User Setting |               |                                      |
|-------------------------|------------------------|-----------------|--------------|---------------|--------------------------------------|
| <b>Start</b>            | PIN Input              | ----            |              |               |                                      |
|                         | Language               | GB              |              |               |                                      |
|                         | Reset                  | OFF             |              |               |                                      |
|                         | Mode                   | 1.01            |              |               | Only Display                         |
|                         | Unicon                 | 1.06            |              |               |                                      |
| <b>Info</b>             | Fanlevel               | 0%              |              |               |                                      |
|                         | Set external1          | 0%              |              |               |                                      |
|                         | Time                   | 12:06           |              |               |                                      |
|                         | Date                   | 18.07.05        |              |               |                                      |
| <b>Setting</b>          | Set Intern 1           | 80%             |              |               |                                      |
|                         | Set Intern 2           | ----            |              |               |                                      |
|                         | Min. Speed             | 0%              |              |               |                                      |
|                         | Max. Speed             | 100%            |              |               |                                      |
|                         | Set external 1         | ON              |              |               |                                      |
|                         | External Error         | *               |              |               |                                      |
| <b>Events</b>           |                        | *               |              |               |                                      |
|                         |                        | *               |              |               |                                      |
|                         |                        | *               |              |               |                                      |
| <b>INSTALLATION</b>     |                        |                 |              |               |                                      |
| <b>Base setup</b>       | Mode                   | <b>1.01</b>     |              |               |                                      |
|                         | E1 Analog IN           | 0-10V           |              |               | <b>E2 Function</b>                   |
|                         | <b>E2 Function</b>     | OFF             |              | 1E            | E1/E2 switch over                    |
|                         | E2 Analog IN           | ----            |              | 4E            | E1/E2 autom. control to higher value |
| <b>Controller Setup</b> | PIN Protection         | OFF             |              |               |                                      |
|                         | Set protection         | OFF             |              |               |                                      |
|                         | Save User Setup        | OFF             |              |               |                                      |
|                         | Limit                  | ----            |              |               |                                      |
|                         | ON Value Group 2       | ----            |              |               |                                      |
|                         | nminm at Group 2       | ----            |              |               |                                      |
| <b>IO Setup</b>         | <b>A1 Function</b>     | 2A              |              |               | <b>A1 / A2 Function</b>              |
|                         | A1 min.                | 0.0 V           |              | 1A            | Constant voltage + 10V               |
|                         | A1 max.                | 10.0 V          |              | 2A            | proportional modulation              |
|                         | A1 Inverting           | OFF             |              | 3A            | proportional signal E1               |
|                         | <b>A2 Function</b>     | 1A              |              | 4A            | proportional signal E2               |
|                         | A2 min.                | 0.0 V           |              | 5A            | Group control                        |
|                         | A2 max.                | 10.0 V          |              |               |                                      |
|                         | A2 Inverting           | OFF             |              |               |                                      |
|                         | <b>D1 Function</b>     | OFF             |              |               | <b>D1..D5 Funktion</b>               |
|                         | D1 Inverting           | ----            |              | 1D            | Enable ON / OFF                      |
|                         | <b>D2 Function</b>     | OFF             |              | 2D            | External fault                       |
|                         | D2 Inverting           | ----            |              | 3D            | Limit ON / OFF                       |
|                         | <b>D3 Function</b>     | OFF             |              | 4D            | Switch over Singnal E1/E2            |
|                         | D3 Inverting           | ----            |              | 5D            | switch over Intern 1 / 2             |
|                         | <b>D4Function</b>      | OFF             |              | 6D            | switch over:Set Intern / Extern      |
|                         | D4 Inverting           | ----            |              |               |                                      |
|                         | <b>D5 Function</b>     | OFF             |              |               |                                      |
|                         | D5 Inverting           | ----            |              |               | <b>K1 / K2 Function</b>              |
|                         | E1 Inverting           | OFF             |              | 1K            | Operation indication                 |
|                         | E2 Inverting           | ----            |              | 2K            | Fault indication                     |
|                         | <b>K1 Function</b>     | 1K              |              | 3K            | external fault                       |
|                         | K1 Inverting           | OFF             |              | 4K            | Limit modulation                     |
|                         | <b>K2 Function</b>     | 2K              |              | 5K            | Limit E1                             |
|                         | K2 Inverting           | OFF             |              | 6K            | Limit E2                             |
| BUS Address             | 247                    |                 | 8K           | Group control |                                      |
| <b>Limits</b>           | <b>Level. Function</b> | OFF             |              |               | <b>Limits (Lmt. Function)</b>        |
|                         | Level min.             | ----            |              | 1L            | Indication with centralized fault    |
|                         | Level max.             | ----            |              | 2L            | Indication as message                |
|                         | Level Delay            | ----            |              |               |                                      |
|                         | <b>Lmt E1 Function</b> | OFF             |              |               |                                      |
|                         | Lmt E1 min.            | ----            |              |               |                                      |
|                         | Lmt E1 max.            | ----            |              |               |                                      |
|                         | Lmt E1 Hyst.           | ----            |              |               |                                      |
|                         | Lmt E1 Delay           | ----            |              |               |                                      |
|                         | <b>Lmt E2 Function</b> | ----            |              |               |                                      |
|                         | Lmt E2 min.            | ----            |              |               |                                      |
|                         | Lmt E2 max.            | ----            |              |               |                                      |
| Lmt E2 Hyst.            | ----                   |                 |              |               |                                      |
| Lmt E2 Delay            | ----                   |                 |              |               |                                      |
| <b>Timer</b>            | Time                   | 13:25           |              |               |                                      |
|                         | Date                   | 18.07.05        |              |               |                                      |
|                         | Summertime Auto.       | OFF             |              |               |                                      |
|                         | Timer Function         | OFF             |              |               |                                      |
|                         | Mon                    |                 |              |               |                                      |
|                         | Mon ON1                | --:             |              |               |                                      |
|                         | Mon OFF1               | --:             |              |               |                                      |
|                         | Mon ON2                | --:             |              |               |                                      |
| Mon OFF2                | --:                    |                 |              |               |                                      |

**Diagnostics** Menu see chapter 16

**9.2 Temperature control 2.01..2.05**

**9.2.1 Basic setting 2.01..2.05**

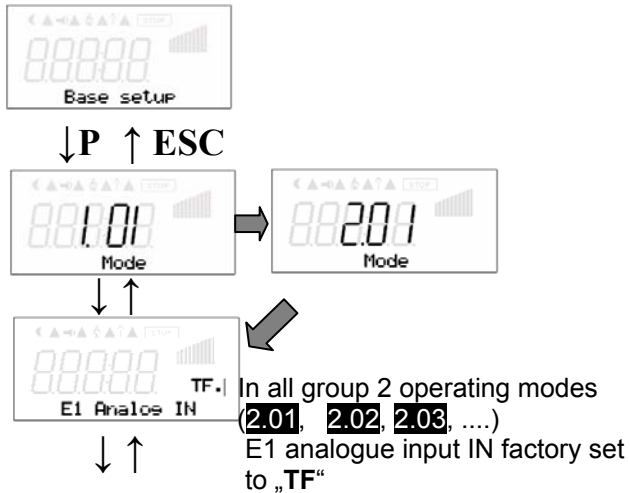

Alternative selection signal: 0-10 V, 0-20 mA, 4-20 mA, jumper accordingly inserted. The sensor measurement-range must be entered in order to correctly display the actual value. Example with a 0-10 V sensor and 0-100° C measurement range



Initial value measuring range



Final value measuring range



Decimal places



display unit



Sensor calibration with calibrated comparison device

**Function analog Input 2**



- External setpoint = Function **1E** by external signal (0-10 V) instead of „Set point 1“  
For sensor type „E1 TF“.: 0-10 V  $\hat{=}$  -27°C..+75.0°C  
  
For sensors with active signal:  
0-10 V  $\hat{=}$  0-100 % sensor measuring range
  - External manual operation via external signal (0-10V) = function **2E**  
Switch over between settings on the device and external manual operation via digital input (☞ IO Setup).
  - **Measurement value = function 7E**  
e.g. for limit indication, display in Info menu “E2 actual”
  - Modes with two sensors  
The function is automatically jointly programmed in operating modes using 2 sensors. The second analog input is thus allocated and additional function allocations are not possible.
- 2.04**  
E2 Function at **4E** preprogrammed = comparison value with control to higher temperature.  
alternative: average of 2 measuring points for this must be reprogrammed on function **3E** preprogrammed sensor type TF..
- 2.05**  
E2 Function at **5E** preprogrammed = regulation on difference temperature between sensor 1 and sensor 2.  
Preprogrammed sensor type TF..

9.2.2 Settings for operation modes 2.01 .. 2.05

**2.01**

Temperature control

**2.02**

Temperature control depending on outdoor temperature

**2.03**

Temperature control with additional functions (heating, shutter, temp. monitoring)

**2.04**

Temperature control with two sensors.

- comparison with control to higher value „E2 Function“ set to comparison „4E“. display during operation: "Control value".
- Alternative: Average calculation of 2 measuring places Display during operation: "Average E1 / E2 („E2 Function“ set to „3E“ )

**2.05**

Temperature control with 2 sensors, regulation on difference temperature

display during operation: "Value of E1 - E2 in K, E1 = reference temperatur, E2 causes positiv (E2<E1) or negative (E2>E1) difference



↓ P ↑ ESC



**Setpoint 1**  
Setting range: -27.0 .. 75°C

↓ ↑



**Setpoint 2**  
„Setpoint 2“ (factory setting OFF)  
e.g. reduced value for night operation. Switch over by digital input.  
(As long as no allocation has been carried out: Display: - - - - IO Setup).

↓ ↑



**Pband (Control range)**  
The control response can be adjusted to the system conditions  
- small control range = greater amplification and shorter control times  
- big control range = longer control times and higher controller stability  
Setting range: 0-102,0 K

↓ ↑



**Min. Speed „n-min“ (minimum output voltage )**  
If required setting of a minimum output voltage e. g. basic speed (minimum airflow rate) of fans.  
Setting range: 0 % up to 100 % (or Max. speed).

↓ ↑



**Max. Speed „n-max“ (maximum output voltage)**  
If required setting of a maximum output voltage, e. g. speed limiter.  
Setting range: 100 % down to „Min speed“.

↓ ↑



**Manual mode**  
OFF = automatic control as function of the set parameters  
ON = automatic control without function, speed setting in menu "Speed manual"

↓ ↑



**Speed manual**  
Manual speed setting without influence by the external signal  
Activation by menu „Manual mode“ or external contact at digital input (IO Setup).

For information about deactivated regulation the adjusted value for manual speed is indicated alternating with the actual value



9.2.3 Functional diagrams temperature control

Example 1:

Temperature control in **factory setting** „Cooling function“ (Controller Setup:  $Ist > Soll = n+$  ON)

(Idealized principle diagram)

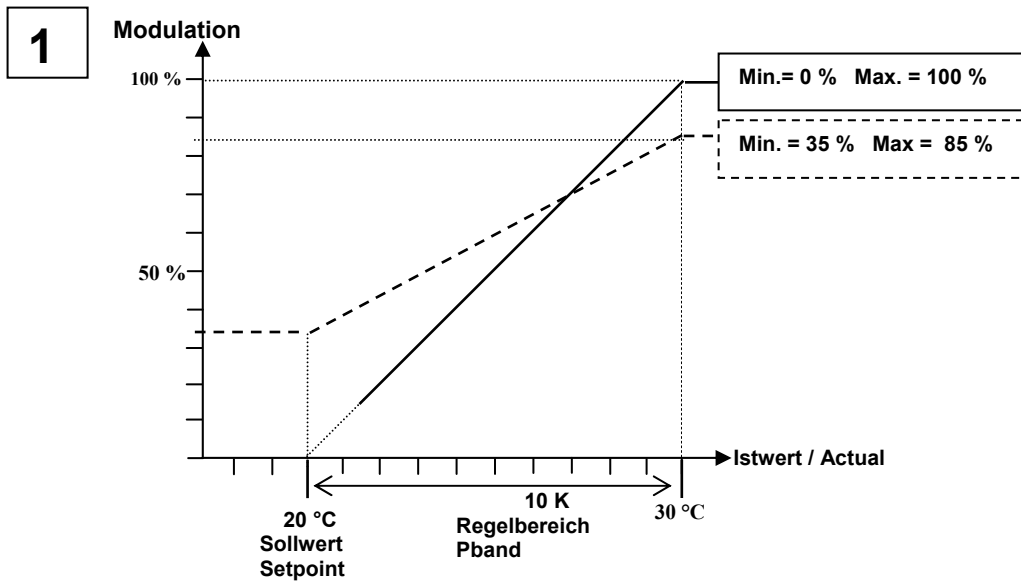

Example 2:

Temperature control in „Heating function“ (Controller Setup:  $Ist > Soll = n+ OFF$ )

(Idealized principle diagram)

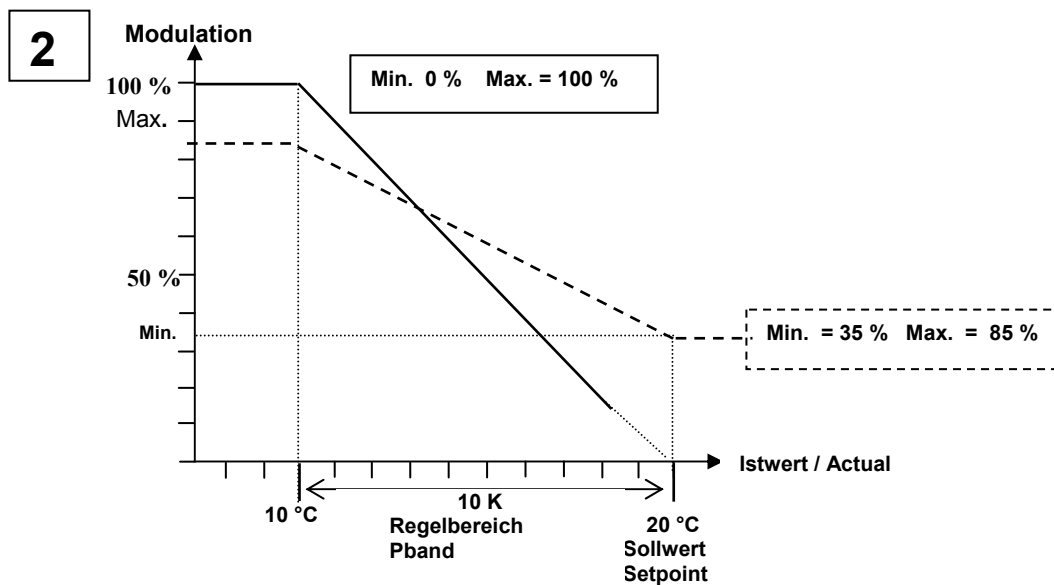

9.2.4 For mode **2.03** temperature controller with additional functions: Signal output 0-10 V

The 0-10 V output signal can, e.g., be used for triggering a shutter or heating.

The target value for this output is the target value (Setpoint) for the ventilation  $\pm$ offset setting. Adjustment range  $\pm 10$  K relative to the active Setpoint.

Example for triggering a shutter servomotor:

At factory setting „0 K“ = synchronous operation.

The analog output is factory set to increasing activation during increasing temperature.

Reprogramming to „Heating function“, i.e., increasing modulation during decreasing temperature is possible (☞ IO Setup).



**Pband** = separately adjustable range of control (P-band) for 0-10 V output

**Min Analog Out** = Minimal output voltage, setting range 0-100 % = 0-10 V

**Max. Analog Out** = Maximal output voltage, setting range 100-0 % = 10-0 V

**Example for signal out 0-10 V**

- Setpoint ventilation 25°C
- Offset -5 K
- Pband 10 K

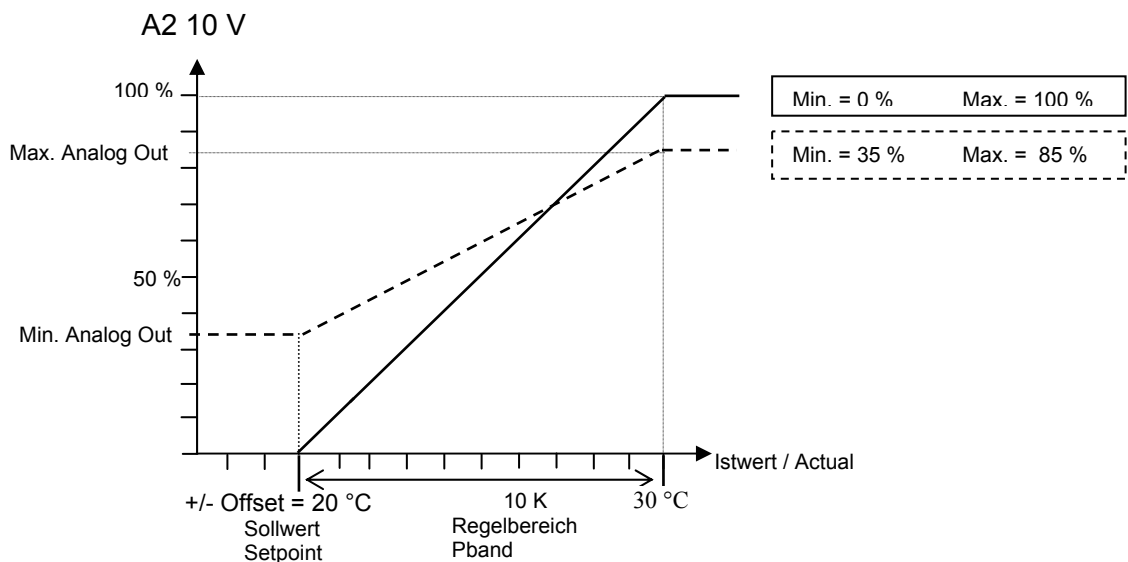

9.2.5 For mode **2.03** Relay output for Heating or Cooling



**Offset Digital Out** = Offset for relay output (K2 is pre-programmed by the factory )

The relay operating point deviates by the adjusted offset of the Setpoint of the ventilation (if relay K2 not inverted, terminal „21“-„24“ bridged).

0.0 K set, i.e.

During negative offset value

During positive offset value

heating „ON“ when: actual value = Setpoint

heating „ON“ when: actual value = Setpoint - offset

heating „ON“ when: actual value = Setpoint + offset



The switching hysteresis of the relay is set to 1 K at factory **Hyst. Digital Out**.

**Example 1**

**Temperature variation with factory setting **9 K** in IO Setup e. g. for controlling a **Heating****

If the ambient temperature is lower than the set operating point, the heating remains switched on. If the ambient temperature exceeds the set operating point of the heating by 2 K, the heating is switched off. I.e., the release point is situated at the hysteresis value over the operating point.

The activated heating is indicated over the fire symbol in the display



**Example 2**

**Temperature variation with reprogramming to **10K** in IO Setup, e.g., for activation of the **cooling****

If the ambient temperature is higher than the set operating point, the cooling remains switched on.

If the ambient temperature falls below the set operating point of the cooling by 2 K, it is switched off. I.e., the OFF point is situated at the hysteresis value under the ON point.

**IO Setup K2 Function for **Heating** = **9K****

**Example 1:** Setpoint 15°C, Offset +5K, Hysteresis 2 K

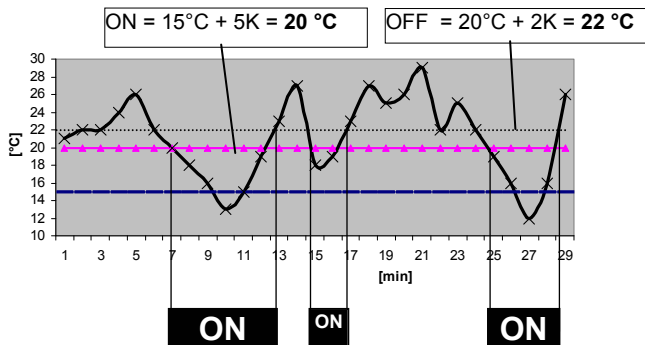

**Example 1:** Setpoint 20°C, Offset -5K, Hysteresis 2 K

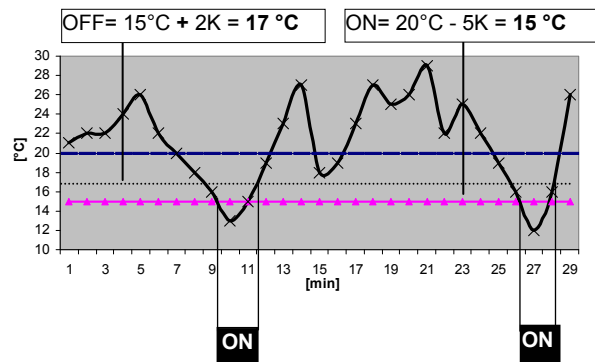

**IO Setup K2 Function for **Cooling** = **10K****

**Example 2:** Setpoint 15°C, Offset +5K, Hysteresis 2 K

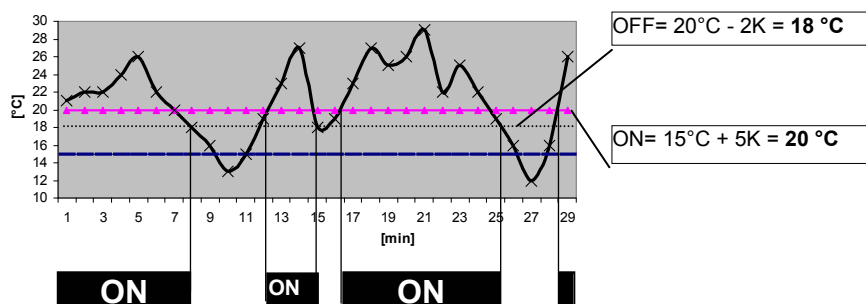

9.2.6 For mode 2.03 Relay output for temperature monitoring

If the set value for the minimum alarm is not reached or the set value for the maximum alarm is exceeded, a message is generated via the alarm symbol in the display. In addition, „Lmt E1 min“ is displayed alternately with the actual value for the minimum alarm and Lmt E1 max for the „Maximum alarm“. An external message follows via the factory-assigned K1 relay. (IO Setup : K1 function = 2K)



Example for display if temperature is falling below setting „Alarm Minimum“

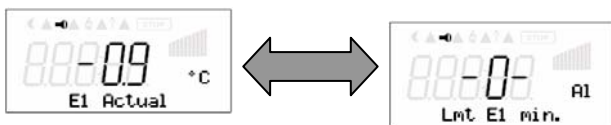

Relay K1 disengages (if not inverted)

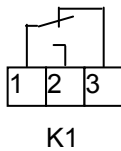

Example for display if temperature is exceeding setting „Alarm Maximum“

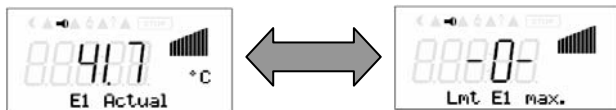

Relay K1 disengages (if not inverted)

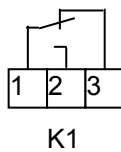

|                                      | Parameter         | factory setting |             |             |             |             | User Setting   |  |
|--------------------------------------|-------------------|-----------------|-------------|-------------|-------------|-------------|--|--|
| <b>S t a r t</b>                     | PIN Input         | ---             | ---         | ---         | ---         | ---         |  |  |
|                                      | Language          | GB              | GB          | GB          | GB          | GB          |  |  |
|                                      | Reset             | OFF             | OFF         | OFF         | OFF         | OFF         |  |  |
|                                      | Mode              | 2.01            | 2.02        | 2.03        | 2.04        | 2.05        |  |  |
|                                      | Unicon            | 1.06            | 1.06        | 1.06        | 1.06        | 1.06        |  |  |
|                                      |                   |                 |             |             |             |             | Only Display   |  |
| <b>I n f o</b>                       | Value E1-E2       |                 |             |             |             |             | -2.4°C   |  |
|                                      | Control value     |                 |             |             | 26.1°C      |             |  |  |
|                                      | E1 Actual         | 30°C            | 10°C        | 30.0°C      | 22.9°C      | 21.9°C      |  |  |
|                                      | E2 Actual         | ---             | ---         | ---         | 26.1°C      | 24.3°C      |  |  |
|                                      | Setpoint 1        | 20.0°C          | 5.0°C       | 20.0°C      | 20.0°C      | 0.0°C       |  |  |
|                                      | Fanlevel          | 0,5             | 0,25        | 0,5         | 1           | 0           |  |  |
|                                      | Misco.            | OFF             | OFF         | OFF         | OFF         | OFF         |  |  |
|                                      | Time              | 12:06           | 12:06       | 12:06       | 12:06       | 12:06       |  |  |
|                                      | Date              | 18.07 05        | 18.07 05    | 18.07 05    | 18.07 05    | 18.07 05    |  |  |
| <b>S e t t i n g</b>                 | Setpoint 1        | 20.0°C          | 5.0°C       | 20.0°C      | 20.0°C      | 0.0°C       |  |  |
|                                      | Setpoint 2        | ---             | ---         | ---         | ---         | ---         |  |  |
|                                      | Pband             | 5.0 K           | 20.0 K      | 5.0 K       | 5.0 K       | 5.0 K       |  |  |
|                                      | Min. Speed        | 0%              | 0%          | 0%          | 0%          | 0%          |  |  |
|                                      | Max. Speed        | 100%            | 100%        | 100%        | 100%        | 100%        |  |  |
|                                      | Manual mode       | OFF             | OFF         | OFF         | OFF         | OFF         |  |  |
|                                      | Speed manual      | 100%            | 100%        | 100%        | 100%        | 100%        |  |  |
|                                      | Offset AnalogOut  |                 |             | 0.0K        |             |             |  |  |
|                                      | Pband AnalogOut   |                 |             | 2.0K        |             |             |  |  |
|                                      | Min. AnalogOut    |                 |             | 0%          |             |             |  |  |
|                                      | Max. AnalogOut    |                 |             | 100%        |             |             |  |  |
|                                      | OffsetDigitalOut  |                 |             | -1.0K       |             |             |  |  |
|                                      | Hyst.DigitalOut   |                 |             | 1.0K        |             |             |  |  |
|                                      | Alarm Minimum     |                 |             | 0.0°C       |             |             |  |  |
| Alarm Maximum                        |                   |                 | 40.0°C      |             |             |             |  |  |
| <b>E v e n t s</b>                   | External Error    | *               | *           | *           | *           | *           |  |  |
|                                      | Sensor 1          | *               | *           | *           | *           | *           |  |  |
|                                      |                   |                 |             |             |             |             |  |  |
| <b>INSTALLATION</b>                  |                   |                 |             |             |             |             |  |  |
| <b>B a s e s e t u p</b>             | Mode              | <b>2.01</b>     | <b>2.02</b> | <b>2.03</b> | <b>2.04</b> | <b>2.05</b> |  |  |
|                                      | E1 Analog IN      | TF              | TF          | TF          | TF          | TF          |  |  |
|                                      | E1 Min.           | ---             | ---         | ---         | ---         | ---         | <b>2.01</b> Temperature control  |  |
|                                      | E1 Max.           | ---             | ---         | ---         | ---         | ---         |  |  |
|                                      | E1 Decimals       | ---             | ---         | ---         | ---         | ---         | <b>2.02</b> Temperature control depending on outdoor temperature   |  |
|                                      | E1 unit           | ---             | ---         | ---         | ---         | ---         |  |  |
|                                      | E1 Offset         | 0.0K            | 0.0K        | 0.0K        | 0.0K        | 0.0K        | <b>2.03</b> Temperature control with additional functions:<br>Heating, shutter, temp. Monitoring   |  |
|                                      | E2 Function       | OFF             | OFF         | OFF         | 4E          | 5E          |  |  |
|                                      | E2 Analog IN      | ---             | ---         | ---         | TF          | TF          |  |  |
|                                      | E2 Min.           | ---             | ---         | ---         | ---         | ---         | <b>2.04</b> Temperature control with two Sensors<br>comparison with control to higher value<br>average calculation of 2 measuring places |  |
|                                      | E2 Max.           | ---             | ---         | ---         | ---         | ---         |  |  |
|                                      | E2 Decimals       | ---             | ---         | ---         | ---         | ---         |  |  |
|                                      | E2 unit           | ---             | ---         | ---         | ---         | ---         |  |  |
|                                      | E2 Offset         | ---             | ---         | ---         | 0.0K        | 0.0K        | <b>2.05</b> Temperature control of 2 sensors<br>regulation on difference temperature   |  |
| <b>C o n t r o l l e r S e t u p</b> | PIN Protection    | OFF             | OFF         | OFF         | OFF         | OFF         |  |  |
|                                      | Set protection    | OFF             | OFF         | OFF         | OFF         | OFF         |  |  |
|                                      | Save User Setup   | OFF             | OFF         | OFF         | OFF         | OFF         |  |  |
|                                      | Alarm Sensors     | OFF             | OFF         | OFF         | OFF         | OFF         | <b>E2 Funktion</b>   |  |
|                                      | Limit             | ---             | ---         | OFF         | ---         | ---         | 1E 0-10 V external Setpoint  |  |
|                                      | Misco.            | OFF             | OFF         | OFF         | OFF         | OFF         | 2E external manual mode  |  |
|                                      | ON Value Group2   | ---             | ---         | ---         | ---         | ---         | 3E Sensor average to E1  |  |
|                                      | nminm bei Gruppe2 | ---             | ---         | ---         | ---         | ---         | 4E Sensor comparison to E1   |  |
|                                      | Val>Set = n+      | ON              | ON          | ON          | ON          | ON          | 5E Sensor difference to E1   |  |
|                                      | Type of control   | P               | P           | P           | P           | P           | 6E Sensor for setpoint lowering<br>(only for mode 4.02 and 5.02)   |  |
|                                      | KP                | 50%             | 50%         | 50%         | 50%         | 50%         | 7 E measurement value for indication and display   |  |
|                                      | KI                | 50%             | 50%         | 50%         | 50%         | 50%         |  |  |
|                                      | KD                | 50%             | 50%         | 50%         | 50%         | 50%         |  |  |
| TI                                   | 0%                | 0%              | 0%          | 0%          | 0%          |             |  |  |

|                        | 2.01               | 2.02     | 2.03     | 2.04     | 2.05     | User Setting |                                   |                                     |  |  |
|------------------------|--------------------|----------|----------|----------|----------|--------------|-----------------------------------|-------------------------------------|--|--|
| <b>IO Setup</b>        | <b>A1 Function</b> | 2A       | 2A       | 2A       | 2A       | 2A           |                                   | <b>A1 / A2 Funktion</b>             |  |  |
|                        | A1 min.            | 0.0 V    | 0.0 V    | 0.0 V    | 0.0 V    | 0.0 V        | 1 A                               | Constant voltage + 10V              |  |  |
|                        | A1 max.            | 10.0 V   | 10.0 V   | 10.0 V   | 10.0 V   | 10.0 V       | 2 A                               | proportional modulation             |  |  |
|                        | A1 Inverting       | OFF      | OFF      | OFF      | OFF      | OFF          | 3 A                               | proportional signal E1              |  |  |
|                        | <b>A2 Function</b> | 1A       | 1A       | 6A       | 1A       | 1A           | 4 A                               | proportional signal E2              |  |  |
|                        | A2 min.            | 0.0 V    | 0.0 V    | 0.0 V    | 0.0 V    | 0.0 V        | 5 A                               | Group control                       |  |  |
|                        | A2 max.            | 10.0 V   | 10.0 V   | 10.0 V   | 10.0 V   | 10.0 V       | 6 A                               | only 2.03 cooling                   |  |  |
|                        | A2 Inverting       | OFF      | OFF      | OFF      | OFF      | OFF          | 7 A                               | only 2.03 Heating                   |  |  |
|                        | <b>D1 Function</b> | OFF      | OFF      | OFF      | OFF      | OFF          |                                   | <b>D1..D5 Funktion</b>              |  |  |
|                        | D1 Inverting       | .----    | .----    | .----    | .----    | .----        | 1 D                               | Enable ON / OFF                     |  |  |
|                        | <b>D2 Function</b> | OFF      | OFF      | OFF      | OFF      | OFF          | 2 D                               | External fault                      |  |  |
|                        | D2 Inverting       | .---     | .---     | .---     | .---     | .---         | 3 D                               | Limit ON / OFF                      |  |  |
|                        | <b>D3 Function</b> | OFF      | OFF      | OFF      | OFF      | OFF          | 4 D                               | Switch over Singnal E1/E2           |  |  |
|                        | D3 Inverting       | .---     | .---     | .---     | .---     | .---         | 5 D                               | switch over Setpoint 1 / 2          |  |  |
|                        | <b>D4Function</b>  | OFF      | OFF      | OFF      | OFF      | OFF          | 6 D                               | switch over: Set Intern / Extern    |  |  |
|                        | D4 Inverting       | .---     | .---     | .---     | .---     | .---         | 7 D                               | Controlling / Manual intern         |  |  |
|                        | <b>D5 Function</b> | OFF      | OFF      | OFF      | OFF      | OFF          | 8 D                               | switch over: ActualValue>Set=n+/-n- |  |  |
|                        | D5 Inverting       | .---     | .---     | .---     | .---     | .---         |                                   | <b>K1..K4 Funktion</b>              |  |  |
|                        | E1 Inverting       | OFF      | OFF      | OFF      | OFF      | OFF          | 1 K                               | Operation indication                |  |  |
|                        | E2 Inverting       | .---     | .---     | .---     | .---     | .---         | 2 K                               | Fault indication                    |  |  |
|                        | <b>K1 Function</b> | 1K       | 1K       | 1K       | 1K       | 1K           | 3 K                               | external fault                      |  |  |
|                        | K1 Inverting       | OFF      | OFF      | OFF      | OFF      | OFF          | 4 K                               | Limit modulation                    |  |  |
|                        | <b>K2 Function</b> | 2K       | 2K       | 9K       | 2K       | 2K           | 5 K                               | Limit E1                            |  |  |
|                        | K2 Inverting       | OFF      | OFF      | OFF      | OFF      | OFF          | 6 K                               | Limit E2                            |  |  |
| BUS Address            | 247                | 247      | 247      | 247      | 247      | 7 K          | Setpoint Offset                   |                                     |  |  |
| <b>Level. Function</b> | OFF                | OFF      | OFF      | OFF      | OFF      | 8 K          | Group control                     |                                     |  |  |
| Level min.             | .---               | .---     | .---     | .---     | .---     | 9 K          | only 2.03 heating funktion        |                                     |  |  |
| Level max.             | .---               | .---     | .---     | .---     | .---     | 10 K         | only 2.03 cooling funktion        |                                     |  |  |
| Level Delay            | .---               | .---     | .---     | .---     | .---     |              | <b>Limits (Lmt. Function)</b>     |                                     |  |  |
| <b>Lmt E1 Function</b> | OFF                | OFF      | 1L       | OFF      | OFF      | 1 L          | Indication with centralized fault |                                     |  |  |
| Lmt E1 min.            | .---               | .---     | 0.0°C    | .---     | .---     | 2 L          | Indication as message             |                                     |  |  |
| Lmt E1 max.            | .---               | .---     | 40.0°C   | .---     | .---     |              |                                   |                                     |  |  |
| Lmt E1 Hyst.           | .---               | .---     | 1.0K     | .---     | .---     |              |                                   |                                     |  |  |
| Lmt E1 Delay           | .---               | .---     | 2sec     | .---     | .---     |              |                                   |                                     |  |  |
| <b>Lmt E2 Function</b> | .---               | .---     | .---     | .---     | .---     |              |                                   |                                     |  |  |
| Lmt E2 min.            | .---               | .---     | .---     | .---     | .---     |              |                                   |                                     |  |  |
| Lmt E2 max.            | .---               | .---     | .---     | .---     | .---     |              |                                   |                                     |  |  |
| Lmt E2 Hyst.           | .---               | .---     | .---     | .---     | .---     |              |                                   |                                     |  |  |
| Lmt E2 Delay           | .---               | .---     | .---     | .---     | .---     |              |                                   |                                     |  |  |
| <b>Offset Function</b> | OFF                | OFF      | OFF      | OFF      | OFF      |              |                                   |                                     |  |  |
| Offset 1               | .---               | .---     | .---     | .---     | .---     |              |                                   |                                     |  |  |
| Offset 2               | .---               | .---     | .---     | .---     | .---     |              |                                   |                                     |  |  |
| Offset Hyst.           | .---               | .---     | .---     | .---     | .---     |              |                                   |                                     |  |  |
| Offset Delay           | .---               | .---     | .---     | .---     | .---     |              |                                   |                                     |  |  |
| <b>Timer</b>           | Time               | 13:25    | 13:25    | 13:25    | 13:25    | 13:25        |                                   |                                     |  |  |
|                        | Date               | 18.07 05 | 18.07 05 | 18.07 05 | 18.07 05 | 18.07 05     |                                   |                                     |  |  |
|                        | Summertime Auto.   | OFF      | OFF      | OFF      | OFF      | OFF          |                                   |                                     |  |  |
|                        | Timer Function     | OFF      | OFF      | OFF      | OFF      | OFF          |                                   |                                     |  |  |
|                        | Mon                |          |          |          |          |              |                                   |                                     |  |  |
|                        | Mon ON1            | -:-      | -:-      | -:-      | -:-      | -:-          |                                   |                                     |  |  |
|                        | Mon OFF1           | -:-      | -:-      | -:-      | -:-      | -:-          |                                   |                                     |  |  |
|                        | Mon ON2            | -:-      | -:-      | -:-      | -:-      | -:-          |                                   |                                     |  |  |
| Mon OFF2               | -:-                | -:-      | -:-      | -:-      | -:-      |              |                                   |                                     |  |  |

**Diagnostics** | Menu see chapter 16

**9.3 Pressure control for condensers refrigeration 3.01 .. 3.04**

**9.3.1 Basic setting 3.01 3.04**

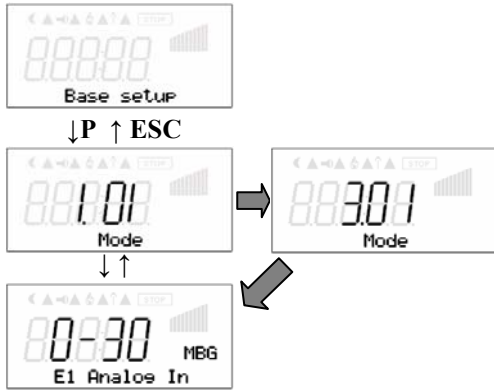

For all Modes in Group 3 (3.01, 3.02, 3.03 ....)  
 Analog input E1 factory setting to "MBG-30I"  
 (measuring range 0-30 bar, proportional output 4-20 mA).  
 Selection sensor: MBG-30I DSF2-25

Alternative selection signal: 0-10 V, 0-20 mA, 4-20 mA,  
 jumper accordingly inserted. The sensor measurement  
 range must be entered in order to display the actual value  
 correctly.

Example: 0-10 V sensor and range 20 bar



Initial value measuring range



Final value measuring range



Decimal places

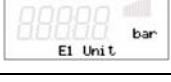

display unit



Sensor calibration with calibrated  
 comparison device

**3.02** and **3.04** operating modes with refrigerant for use with  
 Ziehl-Abegg pressure sensor type MBG-30I or DSF2-25



Upon input of the refrigerant, the device automatically  
 calculates the corresponding temperature for the  
 measured pressure. The settings for offset, target value  
 and the controlling range are then carried out in °C or K.  
 Calculation for relative pressure (differential measurement  
 of pressure relative to ambient pressure  
 No further settings are necessary for pressure sensors  
 from Ziehl-Abegg model e.g. MBG-30I (measurement  
 range 0-30 bar). In the case of sensors with other  
 measurement ranges, the „E1 Min value“ and the „E1 Max  
 Value“ must be entered in °C. To do this, convert the bar  
 values for min and max into °C.

Selection refrigerant :

|       |       |       |       |      |       |       |       |       |
|-------|-------|-------|-------|------|-------|-------|-------|-------|
| R12   | R13   | R13b1 | R22   | R23  | R32   | R114  | R134a | R142B |
| R227  | R401  | R401A | R401B | R402 | R402A | R402B | R404A | R407A |
| R407B | R407C | R500  | R502  | R503 | R507  | R717  |       |       |

Function Analog Input 2



- External setpoint = Function **1E**  
 by external signal (0-10 V) instead of „Setpoint 1“  
 0-10 V  $\hat{=}$  sensor measuring range
- External manual = function **2E**  
 operation via external signal (0-10V)  
 Switch over between settings on the device and external  
 manual operation via digital input  
 (☞ IO Setup).
- Measurement value = function **7E**  
 e.g. for limit indication, display in Info menu “E2 actual”
- Modes with two sensors  
 The function is automatically jointly programmed in  
 operating modes using 2 sensors. The second analog  
 input is thus allocated and additional function allocations  
 are not possible.

**3.04 + 3.03**

E2 Function at **4E** preprogrammed = comparison value with  
 control to higher value (two circuit condensers).

9.3.2 Setting for operation 3.01 .. 3.04

3.01 Pressure control condensers, Setpoint in bar

3.02 Pressure control for condensers with input for refrigerant, Setpoint in °C

3.03 t w o sensors for dual circuit condenser, automatic regulation to the highest pressure (selection amplifier integrated) operation display: „Control value“, Setpoint in bar

3.04 t w o sensors for dual circuit condenser with input for refrigerant automatic regulation to the highest pressure (selection amplifier). Setpoint in °C , also for different refrigerants suitably there comparison of the temperatures. Display during operation: „Control value“



3.01 and 3.03 setting in bar

3.02 and 3.04 input for refrigerant setting in °C

Setpoint 1 (factory setting 12.0 bar)  
Setting range:  
in measuring range of sensor

Setpoint 1 (factory setting 35.0 °C)  
Setting range:  
in measuring range of sensor

Setpoint 2  
Switch over 1/2 by external contact  
( IO Setup)

Setpoint 2  
Switch over 1/2 by external contact  
( IO Setup)

Control range „Pband“  
small range = great amplification and short control time  
Big range = longer control times (higher controller stability)

Control range „Pband“  
small range = great amplification and short control time  
Big range = longer control times (higher controller stability)

Minimal speed  
0-100 %

Minimal speed  
0-100 %

Maximal speed  
100% - Min.

Maximal speed  
100% - Min.

OFF = automatic control  
ON = manual speed setting 0 - 100 %

OFF = automatic control  
ON = manual speed setting 0 - 100 %

Manual speed setting  
0 - 100 % if manual mode = ON

Manual speed setting  
0 - 100 % if manual mode = ON

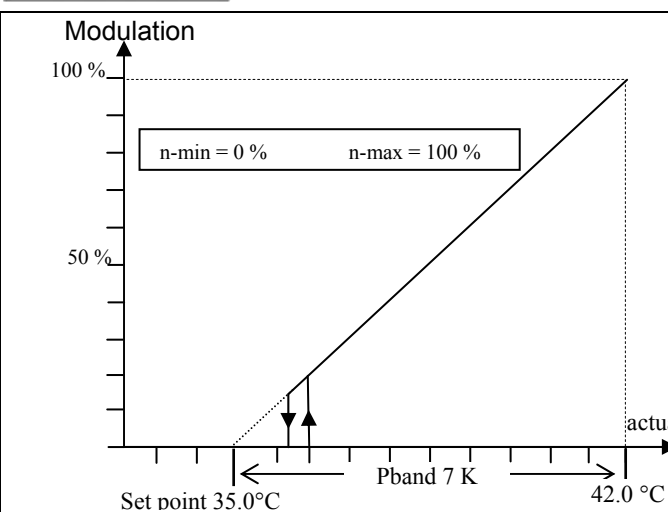
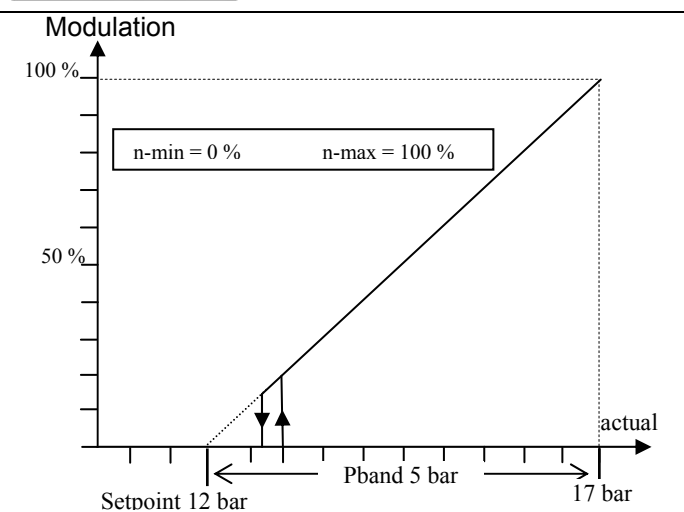

(Idealized prinziple diagram)

(Idealized prinziple diagram)

**i** The factory default presets must be adapted to match the system conditions by a competent person.



9.3.3 Menu for pressure control refrigeration **3.01** .. **3.04**

|                         | Parameter          | factory setting |             |             |             | User Setting                    |  |
|-------------------------|--------------------|-----------------|-------------|-------------|-------------|---------------------------------|--|
| <b>Start</b>            | PIN Input          | .---            | .---        | .---        | .---        |                                 |  |
|                         | Language           | GB              | GB          | GB          | GB          |                                 | only display   |
|                         | Reset              | OFF             | OFF         | OFF         | OFF         |                                 |  |
|                         | Mode               | 3.01            | 3.02        | 3.03        | 3.04        |                                 |  |
|                         | Unicon             | 1.06            | 1.06        | 1.06        | 1.06        |                                 |  |
| <b>Info</b>             | Control value      |                 |             | 10.91 bar   | 22.6°C      |                                 |  |
|                         | E1 Actual          | 10.00 bar       | 19.5°C      | 9.95 bar    | 19.4 °C     |                                 |  |
|                         | E2 Actual          | .---            | .---        | 10.91bar    | 22.5°C      |                                 |  |
|                         | Setpoint 1         | 12.00 bar       | 35.0°C      | 12.00 bar   | 35.0°C      |                                 |  |
|                         | Fanlevel           | 0               | 0           | 0           | 0           |                                 |  |
|                         | Msc0.              | OFF             | OFF         | OFF         | OFF         |                                 |  |
|                         | Time               | 12:06           | 12:06       | 12:06       | 12:06       |                                 |  |
|                         | Date               | 18.07 05        | 18.07 05    | 18.07 05    | 18.07 05    |                                 |  |
| <b>Setting</b>          | Setpoint 1         | 12.00 bar       | 35.0°C      | 12.00 bar   | 35.0°C      |                                 |  |
|                         | Setpoint 2         | .---            | .---        | .---        | .---        |                                 |  |
|                         | Pband              | 5.0 bar         | 7.0 K       | 5.00 bar    | 7.0 K       | <b>3.01</b>                     | Pressure control condensers<br>Setpoint in bar   |
|                         | Min. Speed         | 0%              | 0%          | 0%          | 0%          |                                 |  |
|                         | Max. Speed         | 100%            | 100%        | 100%        | 100%        | <b>3.02</b>                     | Pressure control condensers with input for refrigerant<br>Setpoint in °C   |
|                         | Manual mode        | OFF             | OFF         | OFF         | OFF         |                                 |  |
|                         | Speed manual       | 100%            | 100%        | 100%        | 100%        |                                 |  |
| <b>Events</b>           | External Error     | *               | *           | *           | *           |                                 |  |
|                         | Sensor 1           | *               | *           | *           | *           | <b>3.03</b>                     | 2 sensors for dual circuit condensers<br>regulation to the highest actual value<br>(selection amplifier integrated)<br>Setpoint in bar   |
|                         |                    |                 |             |             |             |                                 |  |
| <b>INSTALLATION</b>     |                    |                 |             |             |             |                                 |  |
| <b>Base setup</b>       | Mode               | <b>3.01</b>     | <b>3.02</b> | <b>3.03</b> | <b>3.04</b> | <b>User Setting</b>             | <b>3.04</b> 2 sensors for dual circuit condensers with input for<br>refrigerant regulation to the highest actual value<br>(selection amplifier integrated)<br>Setpoint in °C<br>also for different refrigerants suitably<br>there comparison of the temperatures |
|                         | E1 Analog IN       | 0-30 MBG        | 0-30 MBG    | 0-30 MBG    | 0-30 MBG    |                                 |  |
|                         | E1 Refrigerant     |                 | R507        |             | R507        |                                 |  |
|                         | E1 Min.            | .---            | .---        | .---        | .---        |                                 |  |
|                         | E1 Max.            | .---            | .---        | .---        | .---        |                                 |  |
|                         | E1 Decimals        | .---            | .---        | .---        | .---        |                                 |  |
|                         | E1 Unit            | .---            | .---        | .---        | .---        |                                 |  |
|                         | E1 Offset          | 0.00 bar        | 0.0K        | 0.00 bar    | 0.0K        |                                 |  |
|                         | <b>E2 Function</b> | OFF             | OFF         | 4 E         | 4E          |                                 | <b>E2 Function</b>   |
|                         | E2 Analog IN       | .---            | .---        | 0-30 MBG    | 0-30 MBG    |                                 |  |
|                         | E2 Refrigerant     |                 |             |             | R507        |                                 | 1E 0-10 V external Setpoint  |
|                         | E2 Min.            | .---            | .---        | .---        | .---        |                                 | 2E external manual mode  |
|                         | E2 Max.            | .---            | .---        | .---        | .---        |                                 | 3E Sensor average to E1  |
|                         | E2 Decimals        | .---            | .---        | .---        | .---        |                                 | 4E Sensor comparison to E1   |
|                         | E2 Unit            | .---            | .---        | .---        | 0.0K        |                                 | 5E Sensor difference to E1   |
| E2 Offset               | .---               | .---            | 0.00 bar    | 0.0K        |             | 6E Sensor for setpoint lowering |  |
| <b>Controller Setup</b> | PIN Protection     | OFF             | OFF         | OFF         | OFF         |                                 | only for mode 4.02 and 5.02)   |
|                         | Set protection     | OFF             | OFF         | OFF         | OFF         |                                 | 7 E measurement value for indication and display   |
|                         | Save User Setup    | OFF             | OFF         | OFF         | OFF         |                                 |  |
|                         | Alarm Sensors      | OFF             | OFF         | OFF         | OFF         |                                 |  |
|                         | Limit              | .---            | .---        | OFF         | .---        |                                 |  |
|                         | Msc0.              | OFF             | OFF         | OFF         | OFF         |                                 |  |
|                         | ON Value Group2    | .---            | .---        | .---        | .---        |                                 |  |
|                         | nminm bei Gruppe2  | .---            | .---        | .---        | .---        |                                 |  |
|                         | Val>Set = n+       | ON              | ON          | ON          | ON          |                                 |  |
|                         | Type of control    | P               | P           | P           | P           |                                 |  |
|                         | KP                 | 50%             | 50%         | 50%         | 50%         |                                 |  |
|                         | KI                 | 50%             | 50%         | 50%         | 50%         |                                 |  |
| KD                      | 50%                | 50%             | 50%         | 50%         |             |                                 |  |
| TI                      | 0%                 | 0%              | 0%          | 0%          |             |                                 |  |

|                        | 3.01               | 3.02     | 3.03     | 3.04     |                                       |  |
|------------------------|--------------------|----------|----------|----------|---------------------------------------|--|
| <b>IO Setup</b>        | <b>A1 Function</b> | 2A       | 2A       | 2A       | 2A                                    |  |
|                        | A1 min.            | 0.0 V    | 0.0 V    | 0.0 V    | 0.0 V                                 | <b>A1 / A2 Function</b>                        |
|                        | A1 max.            | 10.0 V   | 10.0 V   | 10.0 V   | 10.0 V                                | 1 A Constant voltage + 10V                     |
|                        | A1 Inverting       | OFF      | OFF      | OFF      | OFF                                   | 2 A proportional modulation                    |
|                        | <b>A2 Function</b> | 1A       | 1A       | 6A       | 1A                                    | 3 A proportional signal E1                     |
|                        | A2 min.            | 0.0 V    | 0.0 V    | 0.0 V    | 0.0 V                                 | 4 A proportional signal E2                     |
|                        | A2 max.            | 10.0 V   | 10.0 V   | 10.0 V   | 10.0 V                                | 5 A Group control                              |
|                        | A2 Inverting       | OFF      | OFF      | OFF      | OFF                                   | 6 A only 2.03 cooling                          |
|                        | <b>D1 Function</b> | OFF      | OFF      | OFF      | OFF                                   | 7 A only 2.03 Heating                          |
|                        | D1 Inverting       | ---      | ---      | ---      | ---                                   |  |
|                        | <b>D2 Function</b> | OFF      | OFF      | OFF      | OFF                                   | <b>D1..D5 Funktion</b>                         |
|                        | D2 Inverting       | ---      | ---      | ---      | ---                                   | 1 D Enable ON / OFF                            |
|                        | <b>D3 Function</b> | OFF      | OFF      | OFF      | OFF                                   | 2 D External fault                             |
|                        | D3 Inverting       | ---      | ---      | ---      | ---                                   | 3 D Limit ON / OFF                             |
|                        | <b>D4 Function</b> | OFF      | OFF      | OFF      | OFF                                   | 4 D Switch over Singnal E1/E2                  |
|                        | D4 Inverting       | ---      | ---      | ---      | ---                                   | 5 D switch over Setpoint 1 / 2                 |
|                        | <b>D5 Function</b> | OFF      | OFF      | OFF      | OFF                                   | 6 D switch over: Set Intern / Extern           |
|                        | D5 Inverting       | ---      | ---      | ---      | ---                                   | 7 D Controlling / Manual intern                |
|                        | E1 Inverting       | OFF      | OFF      | OFF      | OFF                                   | 8 D switch over: ActualValue > Set = n + / n - |
|                        | E2 Inverting       | ---      | ---      | ---      | ---                                   |  |
|                        | <b>K1 Function</b> | 1K       | 1K       | 1K       | 1K                                    | <b>K1..K4 Funktion</b>                         |
|                        | K1 Inverting       | OFF      | OFF      | OFF      | OFF                                   | 1 K Operation indication                       |
|                        | <b>K2 Function</b> | 2K       | 2K       | 2K       | 2K                                    | 2 K Fault indication                           |
|                        | K2 Inverting       | OFF      | OFF      | OFF      | OFF                                   | 3 K external fault                             |
| BUS Address            | 247                | 247      | 247      | 247      | 4 K Limit modulation                  |  |
| <b>Level. Function</b> | OFF                | OFF      | OFF      | OFF      | 5 K Limit E1                          |  |
| Level min.             | ---                | ---      | ---      | ---      | 6 K Limit E2                          |  |
| Level max.             | ---                | ---      | ---      | ---      | 7 K Setpoint Offset                   |  |
| Level Delay            | ---                | ---      | ---      | ---      | 8 K Group control                     |  |
| <b>Lmt E1 Function</b> | OFF                | OFF      | 1L       | OFF      | 9 K only 2.03 heating funktion        |  |
| Lmt E1 min.            | ---                | ---      | 0.0°C    | ---      | 10 K only 2.03 cooling funktion       |  |
| Lmt E1 max.            | ---                | ---      | 40.0°C   | ---      |                                       |  |
| Lmt E1 Hyst.           | ---                | ---      | 1.0K     | ---      |                                       |  |
| Lmt E1 Delay           | ---                | ---      | 2sec     | ---      |                                       |  |
| <b>Lmt E2 Function</b> | ---                | ---      | ---      | ---      | <b>Limits (Lmt. Function)</b>         |  |
| Lmt E2 min.            | ---                | ---      | ---      | ---      | 1 L Indication with centralized fault |  |
| Lmt E2 max.            | ---                | ---      | ---      | ---      | 2 L Indication as message             |  |
| Lmt E2 Hyst.           | ---                | ---      | ---      | ---      |                                       |  |
| Lmt E2 Delay           | ---                | ---      | ---      | ---      |                                       |  |
| <b>Offset Function</b> | OFF                | OFF      | OFF      | OFF      |                                       |  |
| Offset 1               | ---                | ---      | ---      | ---      |                                       |  |
| Offset 2               | ---                | ---      | ---      | ---      |                                       |  |
| Offset Hyst.           | ---                | ---      | ---      | ---      |                                       |  |
| Offset Delay           | ---                | ---      | ---      | ---      |                                       |  |
| <b>Timer</b>           | Time               | 13:25    | 13:25    | 13:25    | 13:25                                 |  |
|                        | Date               | 18.07 05 | 18.07 05 | 18.07 05 | 18.07 05                              |  |
|                        | Summertime Auto.   | OFF      | OFF      | OFF      | OFF                                   |  |
|                        | Timer Function     | OFF      | OFF      | OFF      | OFF                                   |  |
|                        | Mon                |          |          |          |                                       |  |
|                        | Mon ON1            | ↔        | ↔        | ↔        | ↔                                     |  |
|                        | Mon OFF1           | ↔        | ↔        | ↔        | ↔                                     |  |
|                        | Mon ON2            | ↔        | ↔        | ↔        | ↔                                     |  |
| Mon OFF2               | ↔                  | ↔        | ↔        | ↔        |                                       |  |

**Diagnostics** Menu see chapter 16

**9.4 Pressure control for ventilation systems 4.01-4.03**

**9.4.1 Basic setting 4.01-4.03**

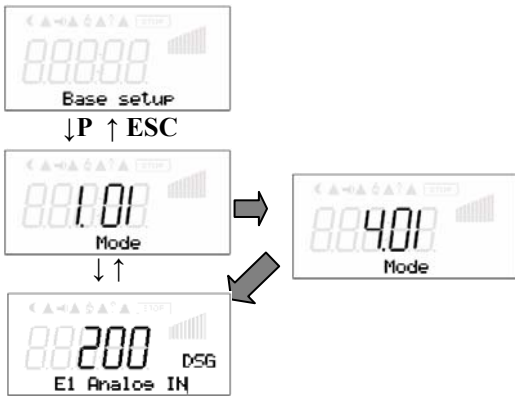

Analog In E1 factory setting to DSG200  
 Selection sensor measuring range: DSG 50, \*DSG100, DSG200, \*DSG300, DSG500, DSG1000, DSG2000, DSG4000, DSG6000  
 (\* no Ziehl-Abegg standard type)

For sensors with 0-20 mA, 4-20 mA signal put Jumper accordingly and select measuring range DSG50 .. DSG6000.  
 For not preprogrammed measuring range the sensor measurement range must be entered in order to display the actual value correctly.  
 Example with a 0-10 V sensor and 0-400 Pa measurement range (proportional output signal)

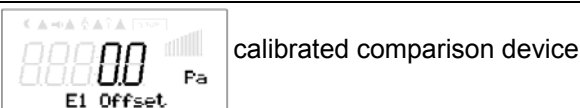
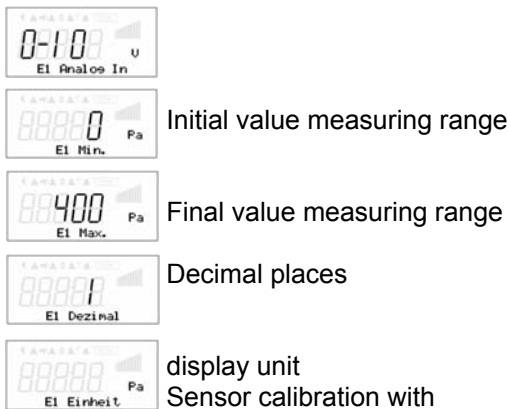

**Function Analog Input 2**



- External setpoint = Function 1E by external signal (0-10 V) instead of „Setpoint 1“  
 0-10 V ^ sensor measuring range
- External manual operation via external signal (0-10V) = function 2E  
 Switch over between settings on the device and external manual operation via digital input (☞ IO Setup).
- Measurement value = function 7E  
 e.g. for limit indication, display in Info menu “E2 actual”
- Modes with two sensors  
 The function is automatically jointly programmed in operating modes using 2 sensors. The second analog input is thus allocated and additional function allocations are not possible.

**4.02**

E2 Function at 6E preprogrammed = sensor for setpoint lowering.  
 preprogrammed sensor type TF..

9.4.2 Setting for operation modes 4.01 and 4.02

**4.01** pressure control, setpoint in Pa

**4.02** Pressure control for ventilation systems setpoint depending on outdoor temperature Setpoint in Pa (hPa, mbar) and temperature in °C.



↓P ↑ESC



Setpoint 1  
Setting range:  
in measuring range of sensor

↓ ↑



Setpoint 2  
Switch over 1/2 by external contact  
IO Setup

↓ ↑



Control range „Pband“  
small range = great amplification  
and short control time  
Big range = longer control times  
(higher controller stability)

↓ ↑



Minimal speed  
0-100 %

↓ ↑



Maximal speed  
100% - Min.

↓ ↑



OFF = automatic control  
ON = manual speed setting  
0 - 100 %

↓ ↑



Manual speed setting  
0 - 100 % if manual mode = ON

**Additional menu item for mode 4.02 with outside-temperature dependent target-setpoint**

An outside temperature compensation can be activated (sensor connection E2 to analog IN 2) when being operated as a pressure regulation device. An optimal building climate, e.g., can be achieved through this. Through this function, the set and active Setpoint1/2 is automatically changed proportional to the measured outside temperature (Info: "Setpoint control").



Temperature range in which the setpoint change continuously with outside temperature

↓ ↑



Setpoint reducing will start below this outside temperature (start point)

↓ ↑



Minimum pressure for very low outside temperature

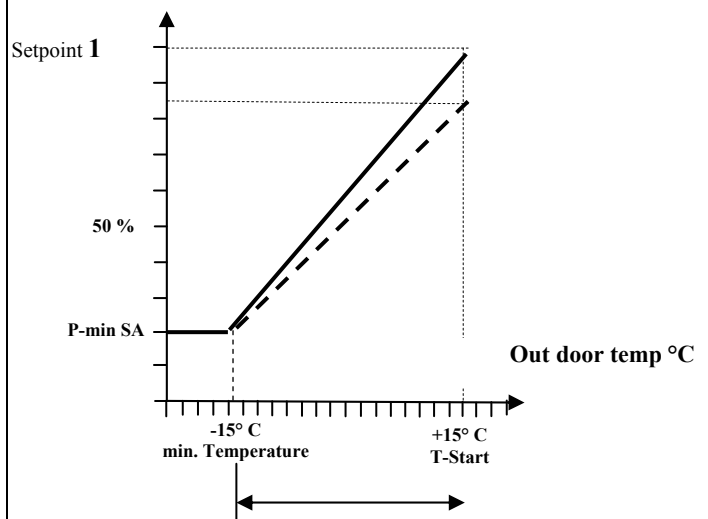

9.4.3 Menu for pressure control airconditioning **4.01** ..**4.02**

|                                  | Parameter         | factory setting |             | User Setting |   |
|----------------------------------|-------------------|-----------------|-------------|--------------|---|
| <b>S</b> <b>Start</b>            | PIN Input         | .----           | .----       |              |   |
|                                  | Language          | GB              | GB          |              |   |
|                                  | Reset             | OFF             | OFF         |              | only display  |
|                                  | Mode              | 4.01            | 4.02        |              |   |
|                                  | Unicon            | 1.06            | 1.06        |              |   |
| <b>I</b> <b>Info</b>             | E1 Actual         | 88.7 Pa         | 88.7 Pa     |              |   |
|                                  | E2 Actual         | .----           | 21.0 °C     |              |   |
|                                  | Setpoint 1        | 100.0 Pa        | 100.0 Pa    |              |   |
|                                  | Setpoint control  |                 | 100.0 Pa    |              |   |
|                                  | Fanlevel          | 0               | 0           |              |   |
|                                  | Msc.              | OFF             | OFF         |              |   |
|                                  | Time              | 12:06           | 12:06       |              |   |
|                                  | Date              | 18.07 05        | 18.07 05    |              |   |
| <b>S</b> <b>Setting</b>          | Setpoint 1        | 100.0 Pa        | 100.0 Pa    |              |   |
|                                  | Setpoint 2        | .----           | .----       |              |   |
|                                  | Pband             | 100.0 Pa        | 100.0 Pa    |              |   |
|                                  | Min. Speed        | 0%              | 0%          |              |   |
|                                  | Max. Speed        | 100%            | 100%        |              |   |
|                                  | Manual mode       | OFF             | OFF         |              |   |
|                                  | Speed manual      | 100%            | 100%        |              |   |
|                                  | T-Band SD         |                 | 30.0 K      |              |   |
|                                  | T-Start SD        |                 | 15.0°C      |              |   |
| P-Min SD                         |                   | 70.0 Pa         |             |              |   |
| <b>E</b> <b>Events</b>           | External Error    | *               | *           |              |   |
|                                  | Sensor 1          | *               | *           |              |   |
|                                  |                   |                 |             |              |   |
|                                  |                   |                 |             |              |   |
| <b>INSTALLATION</b>              |                   |                 |             |              |   |
| <b>B</b> <b>Base setup</b>       | Mode              | <b>4.01</b>     | <b>4.02</b> |              | <b>4.01</b> Pressure control airconditioning                  |
|                                  | E1 Analog IN      | 200 DSG         | 200 DSG     |              |   |
|                                  | E1 Min.           | .----           | .----       |              | <b>4.02</b> Pressure control depending on outdoor temperature |
|                                  | E1 Max.           | .----           | .----       |              |   |
|                                  | E1 Decimals       | .----           | .----       |              |   |
|                                  | E1 unit           | .----           | .----       |              |   |
|                                  | E1 Offset         | 0.0 Pa          | 0.0 Pa      |              |   |
|                                  | E2 Function       | OFF             | 6 E         |              |   |
|                                  | E2 Analog IN      | .----           | TF          |              |   |
|                                  | E2 Min.           | .----           | .----       |              |   |
|                                  | E2 Max.           | .----           | .----       |              |   |
|                                  | E2 Decimals       | .----           | .----       |              |   |
|                                  | E2 unit           | .----           | .----       |              |   |
|                                  | E2 Offset         | .----           | 0.0 K       |              |   |
|                                  |                   |                 |             |              | <b>E2 Function</b>  |
|                                  |                   |                 |             |              | 1E 0-10 V external Setpoint                                   |
|                                  |                   |                 |             |              | 2E external manual mode                                       |
|                                  |                   |                 |             |              | 3E Sensor average to E1                                       |
|                                  |                   |                 |             |              | 4E Sensor comparison to E1                                    |
|                                  |                   |                 |             |              | 5E Sensor difference to E1                                    |
|                                  |                   |                 |             |              | 6E Sensor for setpoint lowering                               |
|                                  |                   |                 |             |              | (only for mode 4.02 and 5.02)                                 |
|                                  |                   |                 |             |              | 7 E measurement value for indication and display              |
| <b>C</b> <b>Controller Setup</b> | PIN Protection    | OFF             | OFF         |              |   |
|                                  | Set protection    | OFF             | OFF         |              |   |
|                                  | Save User Setup   | OFF             | OFF         |              |   |
|                                  | Alarm Sensors     | OFF             | OFF         |              |   |
|                                  | Limit             | .----           | .----       |              |   |
|                                  | Msc.              | OFF             | OFF         |              |   |
|                                  | ON Value Group2   | .----           | .----       |              |   |
|                                  | nminm bei Gruppe2 | .----           | .----       |              |   |
|                                  | Val>Set = n+      | OFF             | OFF         |              |   |
|                                  | Type of control   | Pid             | Pid         |              |   |
|                                  | KP                | 50%             | 50%         |              |   |
|                                  | KI                | 50%             | 50%         |              |   |
|                                  | KD                | 50%             | 50%         |              |   |
| TI                               | 0%                | 0%              |             |              |   |

|                    | 4.01                   | 4.02     | User Setting |                          |                                       |
|--------------------|------------------------|----------|--------------|--------------------------|---------------------------------------|
| <b>IO Setup</b>    | <b>A1 Function</b>     | 2A       | 2A           |                          |                                       |
|                    | A1 min.                | 0.0 V    | 0.0 V        |                          | <b>A1 / A2 Function</b>               |
|                    | A1 max.                | 10.0 V   | 10.0 V       |                          | 1 A Constant voltage + 10V            |
|                    | A1 Inverting           | OFF      | OFF          |                          | 2 A proportional modulation           |
|                    | <b>A2 Function</b>     | 1A       | 1A           |                          | 3 A proportional signal E1            |
|                    | A2 min.                | 0.0 V    | 0.0 V        |                          | 4 A proportional signal E2            |
|                    | A2 max.                | 10.0 V   | 10.0 V       |                          | 5 A Group control                     |
|                    | A2 Inverting           | OFF      | OFF          |                          | 6 A only 2.03 cooling                 |
|                    | <b>D1 Function</b>     | OFF      | OFF          |                          | 7 A only 2.03 Heating                 |
|                    | D1 Inverting           | .----    | .----        |                          |                                       |
|                    | <b>D2 Function</b>     | OFF      | OFF          |                          | <b>D1..D5 Funktion</b>                |
|                    | D2 Inverting           | .----    | .----        |                          | 1 D Enable ON / OFF                   |
|                    | <b>D3 Function</b>     | OFF      | OFF          |                          | 2 D External fault                    |
|                    | D3 Inverting           | .----    | .----        |                          | 3 D Limit ON / OFF                    |
|                    | <b>D4Function</b>      | OFF      | OFF          |                          | 4 D Switch over Singnal E1/E2         |
|                    | D4 Inverting           | .----    | .----        |                          | 5 D switch over Setpoint 1 / 2        |
|                    | <b>D5 Function</b>     | OFF      | OFF          |                          | 6 D switch over:Set Intern / Extern   |
|                    | D5 Inverting           | .----    | .----        |                          | 7 D Controlling / Manual intern       |
|                    | E1 Inverting           | OFF      | OFF          |                          | 8 D switch over:ActualValue>Set=n+/n- |
|                    | E2 Inverting           | .----    | .----        |                          |                                       |
| <b>K1 Function</b> | 1K                     | 1K       |              | <b>K1..K4 Funktion</b>   |                                       |
| K1 Inverting       | OFF                    | OFF      |              | 1 K Operation indication |                                       |
| <b>K2 Function</b> | 2K                     | 2K       |              | 2 K Fault indication     |                                       |
| K2 Inverting       | OFF                    | OFF      |              | 3 K external fault       |                                       |
| BUS Address        | 247                    | 247      |              | 4 K Limit modulation     |                                       |
| <b>Limits</b>      | <b>Level. Function</b> | OFF      | OFF          |                          | 5 K Limit E1                          |
|                    | Level min.             | .----    | .----        |                          | 6 K Limit E2                          |
|                    | Level max.             | .----    | .----        |                          | 7 K Setpoint Offset                   |
|                    | Level Delay            | .----    | .----        |                          | 8 K Group control                     |
|                    | <b>Lmt E1 Function</b> | OFF      | OFF          |                          | 9 K only 2.03 heating funktion        |
|                    | Lmt E1 min.            | .----    | .----        |                          | 10 K only 2.03 cooling funktion       |
|                    | Lmt E1 max.            | .----    | .----        |                          |                                       |
|                    | Lmt E1 Hyst.           | .----    | .----        |                          |                                       |
|                    | Lmt E1 Delay           | .----    | .----        |                          |                                       |
|                    | <b>Lmt E2 Function</b> | .----    | .----        |                          | <b>Limits (Lmt. Function)</b>         |
|                    | Lmt E2 min.            | .----    | .----        |                          | 1 L Indication with centralized fault |
|                    | Lmt E2 max.            | .----    | .----        |                          | 2 L Indication as message             |
|                    | Lmt E2 Hyst.           | .----    | .----        |                          |                                       |
|                    | Lmt E2 Delay           | .----    | .----        |                          |                                       |
|                    | <b>Offset Function</b> | OFF      | OFF          |                          |                                       |
|                    | Offset 1               | .----    | .----        |                          |                                       |
|                    | Offset 2               | .----    | .----        |                          |                                       |
|                    | Offset Hyst.           | .----    | .----        |                          |                                       |
|                    | Offset Delay           | .----    | .----        |                          |                                       |
|                    | <b>Timer</b>           | Time     | 13:25        | 13:25                    |                                       |
| Date               |                        | 18.07 05 | 18.07 05     |                          |                                       |
| Summertime Auto.   |                        | OFF      | OFF          |                          |                                       |
| Timer Function     |                        | OFF      | OFF          |                          |                                       |
| Mon                |                        |          |              |                          |                                       |
| Mon ON1            |                        | --       | --           |                          |                                       |
| Mon OFF1           |                        | --       | --           |                          |                                       |
| Mon ON2            |                        | --       | --           |                          |                                       |
| Mon OFF2           | --                     | --       |              |                          |                                       |

**Diagnostics** Menu see chapter 16

9.5 Volume control **5.01**, **5.02**

9.5.1 Basic setting **5.01**, **5.02**

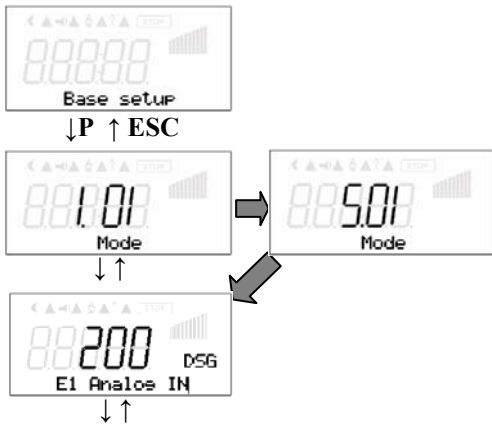

For all modes in group 5 (**5.01** and **5.02** ....)  
Analog In E1 factory setting to DSG200

Selection sensor measuring range: **DSG 50**, **\*DSG100**  
**DSG200**, **\*DSG300** **DSG500**, **DSG1000**, **DSG2000**,  
**DSG4000**, **DSG6000**

(\* no Ziehl-Abegg standard type)

For sensors with 0-20 mA, 4-20 mA signal put Jumper accordingly and select measuring range **DSG50** .. **DSG6000**.

**E1 K-Factor**  
Input of the K of factor dependent on the fan (inlet duct)  
setting range 0..7.000

**E1 Offset**  
Sensor calibration with calibrated comparison device

Function Analog Input 2



- External setpoint = Function **1E** by external signal (0-10 V) instead of „Setpoint 1“  
0-10 V  $\hat{=}$  0-100 % setting range
- External manual operation via external signal (0-10V) = function **2E**  
Switch over between settings on the device and external manual operation via digital input (☞ IO Setup).
- Measurement value = function **7E**  
e.g. for limit indication, display in Info menu “E2 actual”
- Modes with two sensors  
The function is automatically jointly programmed in operating modes using 2 sensors. The second analog input is thus allocated and additional function allocations are not possible.

**5.02**

E2 Function at **6E** preprogrammed = sensor for setpoint lowering. Pre-programmed sensor type TF....

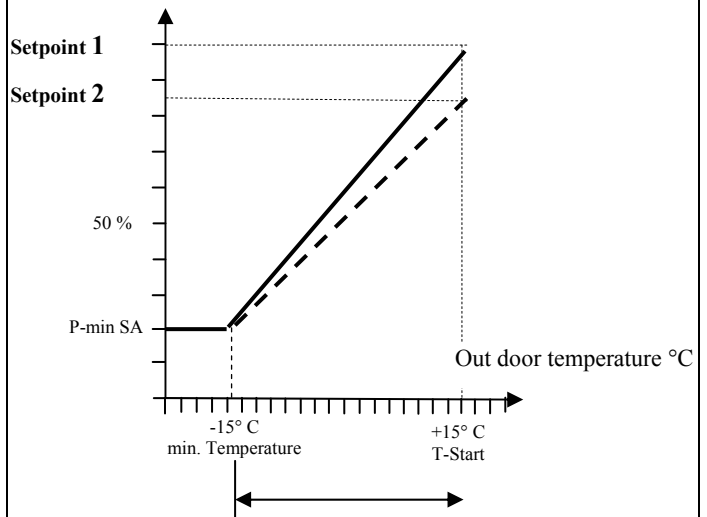

**9.5.2 Setting for operation modes 5.01 and 5.02**

**5.01** Volume control, Setpoint in m3/h (m3/s)

**5.02** Volume control for ventilation systems setpoint depending on outdoor temperature Setpoint in Pa (hPa, mbar) and temperature in °C.

↓ ↑ ESC

Setpoint 1  
Setting range:  
in measuring range of sensor and  
"K" factor

↓ ↑

Setpoint 2  
Switch over 1/2 by external contact  
(☞ IO Setup)

↓ ↑

Control range „Pband“  
small range = short control time  
Big range = longer control times  
(higher controller stability)

↓ ↑

Minimal speed  
0-100 %

↓ ↑

Maximal speed  
100% - Min.

↓ ↑

OFF = automatic control  
ON = manual speed setting 0 - 100 %

↓ ↑

Manual speed setting  
0 - 100 % if manual mode = ON

**Additional menu item for mode 5.02 with outside-temperature dependent target-setpoint**

An outside temperature compensation can be activated (sensor connection E2 to analog IN 2) when being operated as a pressure regulation device. An optimal building climate, e.g., can be achieved through this. Through this function, the set and active Setpoint1/2 is automatically changed proportional to the measured outside temperature (☞ Info: "Setpoint control").

↓ ↑

Temperature range in which the  
setpoint change continuously with  
outside temperature

↓ ↑

Setpoint reducing will start below  
this outside temperature (start  
point)

↓ ↑

Minimum air volume for very low  
outside temperature



9.5.3 Menu for air volume control 5.01 ..5.02

|                         | Parameter          | factory setting | User Setting |   |
|-------------------------|--------------------|-----------------|--------------|---|
| <b>Start</b>            | PIN Input          | .----           | .----        |   |
|                         | Language           | GB              | GB           |   |
|                         | Reset              | OFF             | OFF          | only display  |
|                         | Mode               | 5.01            | 5.02         |   |
|                         | Unicon             | 1.06            | 1.06         |   |
| <b>Info</b>             | E1 Actual          | 712 m3h         | 712 m3h      |   |
|                         | E2 Actual          | .----           | 21.0 °C      |   |
|                         | Setpoint 1         | 530m3h%         | 530m3h%      |   |
|                         | Setpint control    |                 | 530m3h%      |   |
|                         | Fanlevel           | 0               | 0            |   |
|                         | Msc0.              | OFF             | OFF          |   |
|                         | Time               | 12:06           | 12:06        |   |
|                         | Date               | 18.07 05        | 18.07 05     |   |
| <b>Setting</b>          | Setpoint 1         | 530m3h          | 530m3h       |   |
|                         | Setpoint 2         | .----           | .----        |   |
|                         | Pband              | 530m3h          | 530m3h       |   |
|                         | Min. Speed         | 0%              | 0%           |   |
|                         | Max. Speed         | 100%            | 100%         |   |
|                         | Manual mode        | OFF             | OFF          |   |
|                         | Speed manual       | 100%            | 100%         |   |
|                         | T-Band SD          |                 | 30.0 K       |   |
|                         | T-Start SD         |                 | 15.0°C       |   |
| P-Min SD                |                    | 70.0 Pa         |              |   |
| <b>Events</b>           | External Error     | *               | *            |   |
|                         | Sensor 1           | *               | *            |   |
|                         |                    |                 |              |   |
| <b>INSTALLATION</b>     |                    |                 |              |   |
| <b>Base setup</b>       | Mode               | <b>5.01</b>     | <b>5.02</b>  | <b>5.01</b> Volume control (constant) for ventilation systems |
|                         | E1 Analog IN       | 200 DSG         | 200 DSG      |   |
|                         | E1 K-Factor        | 75              | 75           |   |
|                         | E1 Min.            | .----           | .----        | <b>5.02</b> Volume control depending on outdoor temperature   |
|                         | E1 Max.            | .----           | .----        |   |
|                         | E1 Decimals        | .----           | .----        |   |
|                         | E1 unit            | .----           | .----        |   |
|                         | E1 Offset          | 0 m3h           | 0 m3h        |   |
|                         | <b>E2 Function</b> | OFF             | 6 E          |   |
|                         | E2 Analog IN       | .----           | TF           |   |
|                         | E2 K-Factor        | .----           |              |   |
|                         | E2 Min.            | .----           | .----        |   |
|                         | E2 Max.            | .----           | .----        |   |
|                         | E2 Decimals        | .----           | .----        |   |
| E2 unit                 | .----              | .----           |              |   |
| E2 Offset               | .----              | 0.0 K           |              |   |
|                         |                    |                 |              | <b>E2 Function</b>  |
|                         |                    |                 |              | 1E 0-10 V external Setpoint                                   |
|                         |                    |                 |              | 2E external manual mode                                       |
|                         |                    |                 |              | 3E Sensor average to E1                                       |
|                         |                    |                 |              | 4E Sensor comparison to E1                                    |
|                         |                    |                 |              | 5E Sensor difference to E1                                    |
|                         |                    |                 |              | 6E Sensor for setpoint lowering                               |
|                         |                    |                 |              | 7E measurement value for indication and display               |
| <b>Controller Setup</b> | PIN Protection     | OFF             | OFF          |   |
|                         | Set protection     | OFF             | OFF          |   |
|                         | Save User Setup    | OFF             | OFF          |   |
|                         | Alarm Sensors      | OFF             | OFF          |   |
|                         | Limit              | .----           | .----        |   |
|                         | Msc0.              | OFF             | OFF          |   |
|                         | ON Value Group2    | .----           | .----        |   |
|                         | nminm bei Gruppe2  | .----           | .----        |   |
|                         | Val>Set = n+       | OFF             | OFF          |   |
|                         | Type of control    | Pid             | Pid          |   |
|                         | KP                 | 50%             | 50%          |   |
|                         | KI                 | 50%             | 50%          |   |
| KD                      | 50%                | 50%             |              |   |
| TI                      | 0%                 | 0%              |              |   |

|                        | 5.01               | 5.02                   | User Setting |                               |                                   |                                   |  |
|------------------------|--------------------|------------------------|--------------|-------------------------------|-----------------------------------|-----------------------------------|--|
| <b>IO Setup</b>        | <b>A1 Function</b> | 2A                     | 2A           |                               |                                   |                                   |  |
|                        | A1 min.            | 0.0 V                  | 0.0 V        |                               | <b>A1 / A2 Function</b>           |                                   |  |
|                        | A1 max.            | 10.0 V                 | 10.0 V       |                               | 1 A                               | Constant voltage + 10V            |  |
|                        | A1 Inverting       | OFF                    | OFF          |                               | 2 A                               | proportional modulation           |  |
|                        | <b>A2 Function</b> | 1A                     | 1A           |                               | 3 A                               | proportional signal E1            |  |
|                        | A2 min.            | 0.0 V                  | 0.0 V        |                               | 4 A                               | proportional signal E2            |  |
|                        | A2 max.            | 10.0 V                 | 10.0 V       |                               | 5 A                               | Group control                     |  |
|                        | A2 Inverting       | OFF                    | OFF          |                               | 6 A                               | only 2.03 cooling                 |  |
|                        | <b>D1 Function</b> | OFF                    | OFF          |                               | 7 A                               | only 2.03 Heating                 |  |
|                        | D1 Inverting       | .----                  | .----        |                               |                                   |                                   |  |
|                        | <b>D2 Function</b> | OFF                    | OFF          |                               | <b>D1..D5 Funktion</b>            |                                   |  |
|                        | D2 Inverting       | .----                  | .----        |                               | 1 D                               | Enable ON / OFF                   |  |
|                        | <b>D3 Function</b> | OFF                    | OFF          |                               | 2 D                               | External fault                    |  |
|                        | D3 Inverting       | .----                  | .----        |                               | 3 D                               | Limit ON / OFF                    |  |
|                        | <b>D4Function</b>  | OFF                    | OFF          |                               | 4 D                               | Switch over Singnal E1/E2         |  |
|                        | D4 Inverting       | .----                  | .----        |                               | 5 D                               | switch over Setpoint 1 / 2        |  |
|                        | <b>D5 Function</b> | OFF                    | OFF          |                               | 6 D                               | switch over:Set Intern / Extern   |  |
|                        | D5 Inverting       | .----                  | .----        |                               | 7 D                               | Controlling / Manual intern       |  |
|                        | E1 Inverting       | OFF                    | OFF          |                               | 8 D                               | switch over:ActualValue>Set=n+/n- |  |
|                        | E2 Inverting       | .----                  | .----        |                               |                                   |                                   |  |
|                        | <b>K1 Function</b> | 1K                     | 1K           |                               | <b>K1..K4 Funktion</b>            |                                   |  |
|                        | K1 Inverting       | OFF                    | OFF          |                               | 1 K                               | Operation indication              |  |
|                        | <b>K2 Function</b> | 2K                     | 2K           |                               | 2 K                               | Fault indication                  |  |
|                        | K2 Inverting       | OFF                    | OFF          |                               | 3 K                               | external fault                    |  |
|                        | BUS Address        | 247                    | 247          |                               | 4 K                               | Limit modulation                  |  |
|                        | <b>Limits</b>      | <b>Level. Function</b> | OFF          | OFF                           | 5 K                               | Limit E1                          |  |
|                        |                    | Level min.             | .----        | .----                         | 6 K                               | Limit E2                          |  |
| Level max.             |                    | .----                  | .----        | 7 K                           | Setpoint Offset                   |                                   |  |
| Level Delay            |                    | .----                  | .----        | 8 K                           | Group control                     |                                   |  |
| <b>Lmt E1 Function</b> |                    | OFF                    | OFF          | 9 K                           | only 2.03 heating funktion        |                                   |  |
| Lmt E1 min.            |                    | .----                  | .----        | 10 K                          | only 2.03 cooling funktion        |                                   |  |
| Lmt E1 max.            |                    | .----                  | .----        |                               |                                   |                                   |  |
| Lmt E1 Hyst.           |                    | .----                  | .----        |                               |                                   |                                   |  |
| Lmt E1 Delay           |                    | .----                  | .----        |                               |                                   |                                   |  |
| <b>Lmt E2 Function</b> |                    | .----                  | .----        | <b>Limits (Lmt. Function)</b> |                                   |                                   |  |
| Lmt E2 min.            |                    | .----                  | .----        | 1 L                           | Indication with centralized fault |                                   |  |
| Lmt E2 max.            |                    | .----                  | .----        | 2 L                           | Indication as message             |                                   |  |
| Lmt E2 Hyst.           |                    | .----                  | .----        |                               |                                   |                                   |  |
| Lmt E2 Delay           |                    | .----                  | .----        |                               |                                   |                                   |  |
| <b>Offset Function</b> |                    | OFF                    | OFF          |                               |                                   |                                   |  |
| Offset 1               |                    | .----                  | .----        |                               |                                   |                                   |  |
| Offset 2               |                    | .----                  | .----        |                               |                                   |                                   |  |
| Offset Hyst.           |                    | .----                  | .----        |                               |                                   |                                   |  |
| Offset Delay           |                    | .----                  | .----        |                               |                                   |                                   |  |
| <b>Timer</b>           |                    | Time                   | 13:25        | 13:25                         |                                   |                                   |  |
|                        | Date               | 18.07 05               | 18.07 05     |                               |                                   |                                   |  |
|                        | Summertime Auto.   | OFF                    | OFF          |                               |                                   |                                   |  |
|                        | Timer Function     | OFF                    | OFF          |                               |                                   |                                   |  |
|                        | Mon                |                        |              |                               |                                   |                                   |  |
|                        | Mon ON1            | :-                     | :-           |                               |                                   |                                   |  |
|                        | Mon OFF1           | :-                     | :-           |                               |                                   |                                   |  |
|                        | Mon ON2            | :-                     | :-           |                               |                                   |                                   |  |
| Mon OFF2               | :-                 | :-                     |              |                               |                                   |                                   |  |

**Diagnostics** Menu see chapter 16

**9.6 Air velocity control 6.01**

**9.6.1 Basic setting 6.01**

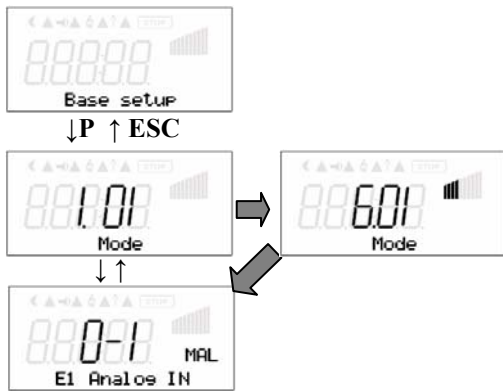

For mode 6.01 E1 factory setting to MAL1 selection sensor measuring range: MAL1, MAL 10

Alternative selection signal: 0-10 V, 0-20 mA, 4-20 mA, jumper accordingly inserted.  
The sensor measurement range must be entered in order to display the actual value correctly. Example with a 0-10 V sensor and 0-100° C measurement range



Initial value measuring range



Final value measuring range



Decimal places



display unit



Sensor calibration with calibrated comparison device

**Funktion analog Eingang 2**

- External setpoint = Function 1E by external signal (0-10 V) instead of „Setpoint 1“  
0-10 V  $\hat{=}$  0-100 % setting range
- External manual operation = function 2E via external signal (0-10V).  
Switch over between settings on the device and external manual operation via digital input (IO Setup).
- Measurement value = function 7E  
e.g. for limit indication, display in Info menu “E2 actual”.

**9.6.2 Settings for operation modes 6.01**



↓ P ↑ ESC



Setpoint 1  
Setting range:  
in measuring range of sensor

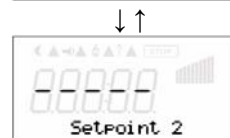

Setpoint 2  
Switch over 1/2 by external contact  
IO Setup



Control range „Pband“  
small range = short control time  
Big range = longer control times (higher controller stability)



Minimal speed  
0-100 %



Maximal speed  
100% - Min.



OFF = automatic control  
ON = manual speed setting 0 - 100 %



















Manual speed setting  
0 - 100 % if manual mode = ON

9.6.3 Menu for air velocity control **6.01**

|                         | Parameter          | factory setting | User Setting |             |                      |  |  |
|-------------------------|--------------------|-----------------|--------------|-------------|----------------------|--|--|
| <b>Start</b>            | PIN Input          | .----           |              |             |                      |  |  |
|                         | Language           | GB              |              |             |                      |  |  |
|                         | Reset              | OFF             |              |             | only display         |  |  |
|                         | Mode               | 6.01            |              |             |                      |  |  |
|                         | Unicon             | 1.06            |              |             |                      |  |  |
| <b>In fo</b>            | E1 Actual          | 0.45m/s         |              |             |                      |  |  |
|                         | E2 Actual          | .----           |              |             |                      |  |  |
|                         | Setpoint 1         | 0.50m/s         |              |             |                      |  |  |
|                         | Fanlevel           | 0               |              |             |                      |  |  |
|                         | Msc0.              | OFF             |              |             |                      |  |  |
|                         | Time               | 12:06           |              |             |                      |  |  |
|                         | Date               | 18.07 05        |              |             |                      |  |  |
| <b>Setting</b>          | Setpoint 1         | 0.50m/s         |              |             |                      |  |  |
|                         | Setpoint 2         | .----           |              |             |                      |  |  |
|                         | Pband              | 0.50m/s         |              |             |                      |  |  |
|                         | Min. Speed         | 0%              |              |             |                      |  |  |
|                         | Max. Speed         | 100%            |              |             |                      |  |  |
|                         | Manual mode        | OFF             |              |             |                      |  |  |
|                         | Speed manual       | 100%            |              |             |                      |  |  |
| <b>Events</b>           | External Error     | *               |              |             |                      |  |  |
|                         | Sensor 1           | *               |              |             |                      |  |  |
|                         |                    |                 |              |             |                      |  |  |
|                         |                    |                 |              |             |                      |  |  |
| <b>INSTALLATION</b>     |                    |                 |              |             |                      |  |  |
| <b>Base setup</b>       | Mode               | <b>6.01</b>     |              | <b>6.01</b> | Air velocity control |  |  |
|                         | E1 Analog IN       | 0-1 MAL         |              |             |                      |  |  |
|                         | E1 Min.            | .----           |              |             |                      |  |  |
|                         | E1 Max.            | .----           |              |             |                      |  |  |
|                         | E1 Decimals        | .----           |              |             |                      |  |  |
|                         | E1 unit            | .----           |              |             |                      |  |  |
|                         | E1 Offset          | 0.00 m/s        |              |             |                      |  |  |
|                         | <b>E2 Function</b> | OFF             |              |             |                      |  |  |
|                         | E2 Analog IN       | .----           |              |             | <b>E2 Function</b>   |  |  |
|                         | E2 Min.            | .----           |              |             | 1E                   | 0-10 V external Setpoint                     |  |
|                         | E2 Max.            | .----           |              |             | 2E                   | external manual mode                         |  |
|                         | E2 Decimals        | .----           |              |             | 3E                   | Sensor average to E1                         |  |
|                         | E2 unit            | .----           |              |             | 4E                   | Sensor comparison to E1                      |  |
|                         | E2 Offset          | .----           |              |             | 5E                   | Sensor difference to E1                      |  |
| <b>Controller Setup</b> | PIN Protection     | OFF             |              |             | 6E                   | Sensor for setpoint lowering                 |  |
|                         | Set protection     | OFF             |              |             |                      | only for mode 4.02 and 5.02)                 |  |
|                         | Save User Setup    | OFF             |              |             | 7 E                  | measurement value for indication and display |  |
|                         | Alarm Sensors      | OFF             |              |             |                      |  |  |
|                         | Limit              | .----           |              |             |                      |  |  |
|                         | Msc0.              | OFF             |              |             |                      |  |  |
|                         | ON Value Group2    | .----           |              |             |                      |  |  |
|                         | nminm bei Gruppe2  | .----           |              |             |                      |  |  |
|                         | Val>Set = n+       | OFF             |              |             |                      |  |  |
|                         | Type of control    | Pid             |              |             |                      |  |  |
|                         | KP                 | 50%             |              |             |                      |  |  |
|                         | KI                 | 50%             |              |             |                      |  |  |
|                         | KD                 | 50%             |              |             |                      |  |  |
| TI                      | 0%                 |                 |              |             |                      |  |  |

|                        |                    |             |  |                               |                                   |                                   |  |
|------------------------|--------------------|-------------|--|-------------------------------|-----------------------------------|-----------------------------------|--|
|                        |                    | <b>5.01</b> |  |                               |                                   |                                   |  |
| <b>IO Setup</b>        | <b>A1 Function</b> | 2A          |  |                               |                                   |                                   |  |
|                        | A1 min.            | 0.0 V       |  |                               | <b>A1 / A2 Function</b>           |                                   |  |
|                        | A1 max.            | 10.0 V      |  |                               | 1 A                               | Constant voltage + 10V            |  |
|                        | A1 Inverting       | OFF         |  |                               | 2 A                               | proportional modulation           |  |
|                        | <b>A2 Function</b> | 1A          |  |                               | 3 A                               | proportional signal E1            |  |
|                        | A2 min.            | 0.0 V       |  |                               | 4 A                               | proportional signal E2            |  |
|                        | A2 max.            | 10.0 V      |  |                               | 5 A                               | Group control                     |  |
|                        | A2 Inverting       | OFF         |  |                               | 6 A                               | only 2.03 cooling                 |  |
|                        | <b>D1 Function</b> | OFF         |  |                               | 7 A                               | only 2.03 Heating                 |  |
|                        | D1 Inverting       | .----       |  |                               |                                   |                                   |  |
|                        | <b>D2 Function</b> | OFF         |  |                               | <b>D1..D5 Funktion</b>            |                                   |  |
|                        | D2 Inverting       | .----       |  |                               | 1 D                               | Enable ON / OFF                   |  |
|                        | <b>D3 Function</b> | OFF         |  |                               | 2 D                               | External fault                    |  |
|                        | D3 Inverting       | .----       |  |                               | 3 D                               | Limit ON / OFF                    |  |
|                        | <b>D4Function</b>  | OFF         |  |                               | 4 D                               | Switch over Singnal E1/E2         |  |
|                        | D4 Inverting       | .----       |  |                               | 5 D                               | switch over Setpoint 1 / 2        |  |
|                        | <b>D5 Function</b> | OFF         |  |                               | 6 D                               | switch over:Set Intern / Extern   |  |
|                        | D5 Inverting       | .----       |  |                               | 7 D                               | Controlling / Manual intern       |  |
|                        | E1 Inverting       | OFF         |  |                               | 8 D                               | switch over:ActualValue>Set=n+/n- |  |
|                        | E2 Inverting       | .----       |  |                               |                                   |                                   |  |
|                        | <b>K1 Function</b> | 1K          |  |                               | <b>K1..K4 Funktion</b>            |                                   |  |
|                        | K1 Inverting       | OFF         |  |                               | 1 K                               | Operation indication              |  |
|                        | <b>K2 Function</b> | 2K          |  |                               | 2 K                               | Fault indication                  |  |
|                        | K2 Inverting       | OFF         |  |                               | 3 K                               | external fault                    |  |
| BUS Address            | 247                |             |  | 4 K                           | Limit modulation                  |                                   |  |
| <b>Level. Function</b> | OFF                |             |  | 5 K                           | Limit E1                          |                                   |  |
| Level min.             | .----              |             |  | 6 K                           | Limit E2                          |                                   |  |
| Level max.             | .----              |             |  | 7 K                           | Setpoint Offset                   |                                   |  |
| Level Delay            | .----              |             |  | 8 K                           | Group control                     |                                   |  |
| <b>Lmt E1 Function</b> | OFF                |             |  | 9 K                           | only 2.03 heating funktion        |                                   |  |
| Lmt E1 min.            | .----              |             |  | 10 K                          | only 2.03 cooling function        |                                   |  |
| Lmt E1 max.            | .----              |             |  |                               |                                   |                                   |  |
| Lmt E1 Hyst.           | .----              |             |  |                               |                                   |                                   |  |
| Lmt E1 Delay           | .----              |             |  |                               |                                   |                                   |  |
| <b>Lmt E2 Function</b> | .----              |             |  | <b>Limits (Lmt. Function)</b> |                                   |                                   |  |
| Lmt E2 min.            | .----              |             |  | 1 L                           | Indication with centralized fault |                                   |  |
| Lmt E2 max.            | .----              |             |  | 2 L                           | Indication as message             |                                   |  |
| Lmt E2 Hyst.           | .----              |             |  |                               |                                   |                                   |  |
| Lmt E2 Delay           | .----              |             |  |                               |                                   |                                   |  |
| <b>Offset Function</b> | OFF                |             |  |                               |                                   |                                   |  |
| Offset 1               | .----              |             |  |                               |                                   |                                   |  |
| Offset 2               | .----              |             |  |                               |                                   |                                   |  |
| Offset Hyst.           | .----              |             |  |                               |                                   |                                   |  |
| Offset Delay           | .----              |             |  |                               |                                   |                                   |  |
| <b>Timer</b>           | Time               | 13:25       |  |                               |                                   |                                   |  |
|                        | Date               | 18.07 05    |  |                               |                                   |                                   |  |
|                        | Summertime Auto.   | OFF         |  |                               |                                   |                                   |  |
|                        | Timer Function     | OFF         |  |                               |                                   |                                   |  |
|                        | Mon                |             |  |                               |                                   |                                   |  |
|                        | Mon ON1            | --:         |  |                               |                                   |                                   |  |
|                        | Mon OFF1           | --:         |  |                               |                                   |                                   |  |
|                        | Mon ON2            | --:         |  |                               |                                   |                                   |  |
| Mon OFF2               | --:                |             |  |                               |                                   |                                   |  |

**Diagnostics** Menu see chapter 16

|   |  |
|---|--|
| <p><b>10. Menu group Start</b></p>    | <p><b>11. Menu group Info</b></p>    |
|  <p>The service menu for the installation can be protected against unintentional changes by a pin code. With further pin codes putting back to pre-setting is possible.</p> <p><b>PIN 0010</b><br/>Opening service menu, if PIN-protection activated</p> <p><b>PIN 1234</b><br/>opening "setting", if "set protection" ON (☞ Controller Setup)</p> <p><b>PIN 9090</b><br/>Restore user setting</p> <p><b>PIN 9091</b><br/>Save user setting (corresponds function "Save user setup ON" ☞ Controller Setup)</p> <p><b>PIN 9095</b><br/>Restore factory setting = delivery status</p>  <p>Example for PIN input <span style="border: 1px solid black; padding: 2px;">0010</span> for opening service menu</p>  <p><b>Menu language</b> by the factory set to <b>English</b>.<br/>In this menu different national languages can be selected (GB = English, D = Deutsch ...).</p>  <p>Complete re-start of the device.</p>  <p>Query of the operating mode</p>  <p>Query of the device software version</p> | <p><b>For mode speed controller 1.01</b></p>  <p>Modulation of the controller device in addition to the bar display.</p>  <p>Display of the type and level of the active default signal in percent (0-100 % <math>\hat{=}</math> 0-10 V, 10-0 V, 0-20 mA, 20-0 mA, 4-20 mA, 20-4 mA).</p> <p>Display: the device operates at :</p> <p>Set „External 1“ = Signal to „E1“ / „GND“<br/>Set „External 2“ = Signal to „E2“ / „GND“<br/>Set „Intern 1“ = Menu „Set intern 1“<br/>Set „Intern 2“ = Menu „Set intern 2“</p> <p><b>Info for mode controller 2.01 .., 3.01 .., 4.01 .., 5.01 .., 6.01 ..,</b></p>  <p>Current actual value measured on the sensor 1. Depending sensor-type, in mbr, m<sup>3</sup>/s, m/s, Pa, %, bar, m<sup>3</sup>/h, °C, V, mA, etc.</p>  <p>For operation with two sensors display for „E2 actual “. If function not active, display <span style="border: 1px solid black; padding: 2px;">-----</span></p> <p>Display of the active target value at which the device operates</p>  <p>„Setpoint 1“ = Menu Setting <span style="border: 1px solid black; padding: 2px;">Setpoint 1</span></p> <p>„Setpoint 2“ = Menu Setting <span style="border: 1px solid black; padding: 2px;">Setpoint 2</span></p> <p>„Ext. Setpoint = setting by external signal 0-10 V. With activated manual mode the display constantly changes between actual value and value for "manual mode".</p>  <p>Modulation of the controller device, in addition to the bar display.</p>  <p>Momentarily status for minimum speed cut off<br/>Msc0.“ : ON = switch off, if Setpoint (<math>\pm</math> Min. speed cut off) is reached<br/>“Msc0“ : OFF = no switch off that means operation with minimum rate of air.</p>  <p>Announcement of the current time</p>  <p>Announcement of the current date</p> |

**12. Controller Setup**



**12.1 PIN Protection**

The adjustments for the installation in the service level can be protected against unintentional modifications. To do this, activate the „PIN protection“.

In order to simplify the initial start-up operation, the service level in the factory setting is free – i.e. accessible without PIN 0010.

**After installation of the device has been carried out, PIN protection should be activated!**

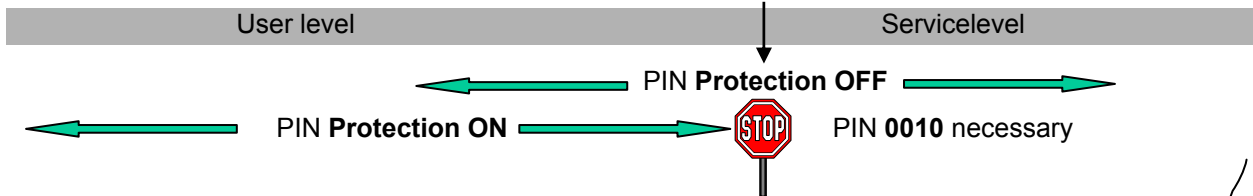

|                  |      |         |        |            |                       |    |
|------------------|------|---------|--------|------------|-----------------------|----|
| Start            | INFO | Setting | Events | Base setup | Controller Setup      | IO |
| ----             | :    | :       | :      | :          | OFF                   |    |
| <b>PIN Input</b> |      |         |        |            | <b>PIN-Protection</b> |    |
| :                | :    | :       | :      | :          |                       |    |

**12.2 Set protection**

The „Settings“ menu for the user’s basic settings (Setpoint, default value, min, max ..) are freely accessible when using the factory settings (i.e. without PIN).

If necessary, these can also be protected against unauthorized modifications by using a PIN (1234). For this, the settings protection must be programmed to „ON“. The settings menu is then no longer visible without inputting a PIN!



**Function only in combination with activated PIN protection!**

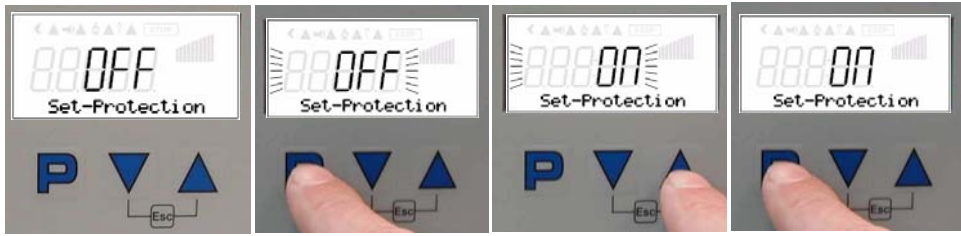

Menu „Setting“ if Set-protection „ON“ only after PIN Input (1234) visible

|              |             |                |               |
|--------------|-------------|----------------|---------------|
| <b>Start</b> | <b>INFO</b> | <b>Setting</b> | <b>Events</b> |
| :            | :           | :              | :             |

**12.3 Save user settings**

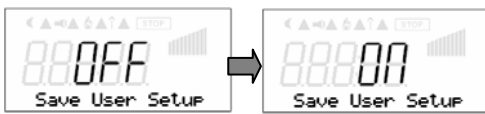

The individually made device configurations (User Settings) can be saved and, with the corresponding PIN input (9090), can be reestablished (↶ Start → PIN input).



**Important information!**

By entering PIN 9095 in the „PIN“ menu in the start menu-group, the device is entirely reset to the pre-delivery condition **Any changes that have been made to the settings are thus lost!**

### 12.4 Sensor Alarm ON / OFF

#### Function only in controller mode!

For "Analog IN 1" and if activated for sensor 2 Analog IN2. In case of an interruption or short-circuit in the sensor conductor, or in case of measured values that lie outside of the device's measurement range, an error message can occur via the alarm symbol in the display and a relay.



The sensor malfunction indicator is factory set to off so that error messages do not interfere with start-up operations. When the alarm sensors are set to **OFF**, the sensor malfunctions are stored merely for informational purposes as "messages" in "Events".



For Alarm OFF  
Message in "Events"



For Alarm ON  
Display alternating to actual value

### 12.5 Limit

An adjustable limitation of the modulation can be activated via a digital input („D1“, „D2“, ..) (depending on the programming, **as long as no allocation is carried out: Display: [----], IO Setup).**

**Limit** value= max. possible modulation (e.g. speed reduction during night operation by time switch).



**Limit** value= max. possible modulation (e.g. speed reduction during night operation by time switch).  
Setting range Limit „Max. Speed“ up to „Min. Speed“  
Factory setting 100 % ^ max. modulation, i. e. no limit.

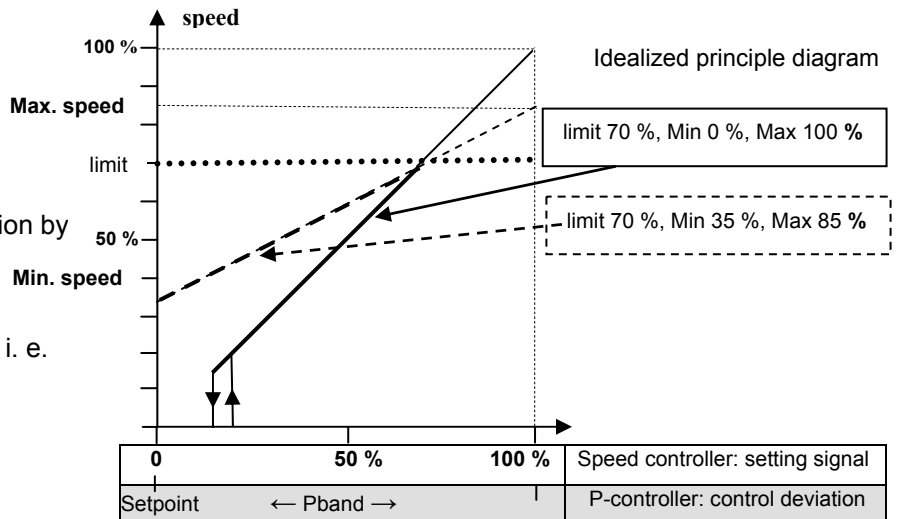

### 12.6 Minimum speed cut off

This function is primarily significant for installation of the device as a pure P Controller in refrigeration and air-conditioning technology.

For operation mode speed controller **1.01** without function!



- **Msc0** = **OFF** (factory setting)  
If no "Min. speed" is adjusted, the fan stops with reaching modulation desired value.  
If "Min. speed" is adjusted (e.g. 20%), then no disconnection of the fan takes place. I.e., always a minimum ventilation is ensured (fan does not go under setting "Min. speed").
- **Msc0** = **ON**  
It takes place a disconnection from setting "Min. speed" to "0", if the given difference is reached related to the desired value. At a plus value (+) before reaching the desired value at a minus value (-) after falling below the desired value.

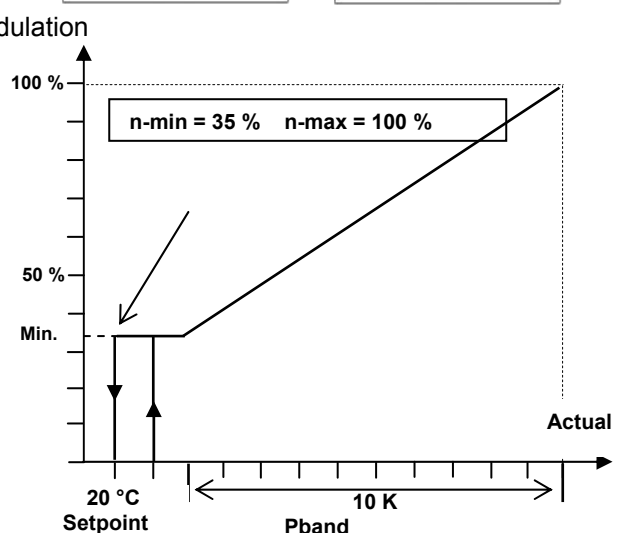



12.7 Second Group

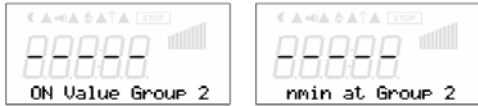

**Second group „indirectly controlled“ (picture 1)**

Analog output „Analog OUT 1“ in IO Setup function **5 A** = group control is programmed.

This output is employed as the default signal for a speed controller. If the default signal or the regulation deviation exceeds the group 2 switch-on point, group 1 is reduced to „n-min group 2“. Starting here, both groups run parallel at maximum power.

**Second group „100 % energized“ (picture 2)**

Relay output (K1 or K2) in IO Setup function **8 K** = group control is programmed.

A contactor is triggered via this relay contact, which directly switches the fans of the second group to mains voltage. If the default signal or the regulation deviation exceeds the „Group 2 ON value“ switch-on point, the relay for the second group switches on and the speed of the first group is lowered to an adjustable minimum value. After that, the speed of the first group increases back up to maximum.

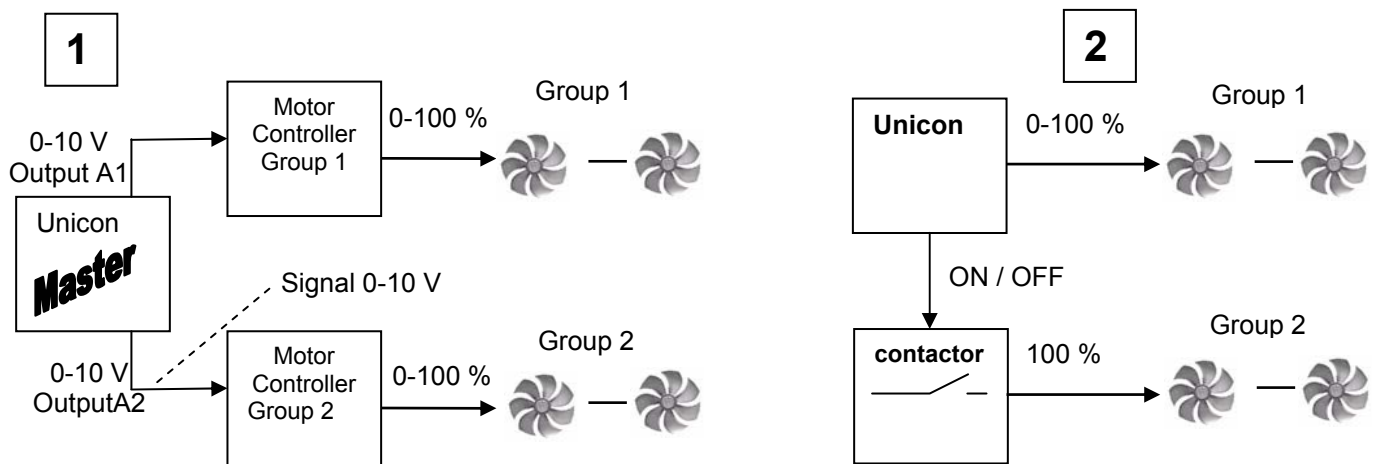

12.8 Reverse action of the control function (actual Value>Set = n+)

For the effect of the regulation there are **TWO** functions

- 1. Setting **ON** for **actual Value>Set = n+  $\Delta$**  increasing output voltage at increasing actual value
- 2. Setting **OFF** for **actual Value>Set = n+  $\Delta$**  decreasing output voltage at increasing actual value

For special applications an **external switch over of control function is possible** (☞ IO Setup → Reverse for control function).

Factory setting depending on selected mode

| Mode    | Control function    |
|---------|---------------------|
| 1.01    | No control function |
| 2.01 .. | ON                  |
| 3.01 .. | ON                  |
| 4.01 .. | OFF                 |
| 5.01 .. | OFF                 |
| 6.01 .. | OFF                 |

Example for temperature control (Idealized principle diagram)

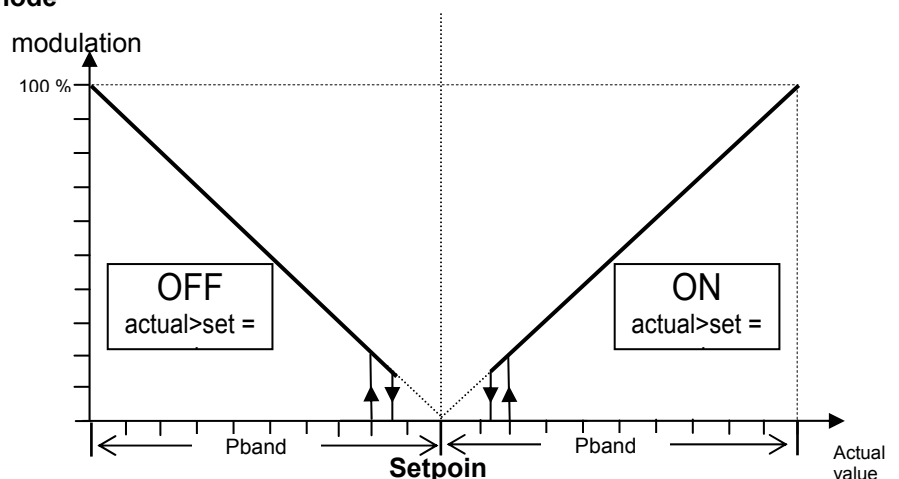

**12.9 Controller configuration (controller type) and controller action )**

The controller configuration is automatically carried out during selection of the application related mode of operation. The factory presets in accordance with the mode of operation are based on many years of experience, which is suitable for many applications. Under special circumstances, these can be individually adapted.

The **type of control** determines the method with which the controlled value behaves in case of a difference between the target and current values. For this, the control technology has standard algorithms, which consist of a combination of three methods:

Selection P, PID

**P**control (**P**roportional component, proportion of the absolute deviation)

**I**control (**I**ntegral component, proportion of the sum of all deviations)

**D**control (**D**ifferential component, proportion of the last difference)

**With pure P controllers (controller type P), the following described settings do not have any function!**

If needed, the most suitable combination for the respective control system can be determined from these proportions.



➔ P-component = reaction time  
Setting range 0-200 %  
smaller = more slowly  
bigger = faster



➔ I-component = accuracy,  
correction time  
Setting range 0-200 %  
smaller = faster  
bigger = more slowly



➔ D-component = stability by  
slower  
correction time  
Setting range 0-200 %  
smaller = faster  
bigger = more slowly



➔ Integration time = correction time  
Setting range 0-200 %  
smaller = faster  
bigger = more slowly

13.1 Analog Output A (Analog OUT 1)

13.1.1 Function analog output A (Analog OUT 1)

The analog outputs 0-10 V can be allocated with various functions.

Den analogen Ausgängen 0-10 V können unterschiedliche Funktionen zugeordnet werden.

Terminals 19 (A1) - 20 (GND) = Analog OUT 1 ( $I_{max}$  10 mA) Pre-setting for speed controller input

Terminals 21 (A2) - 22 (GND) = Analog OUT 2 ( $I_{max}$  10 mA)

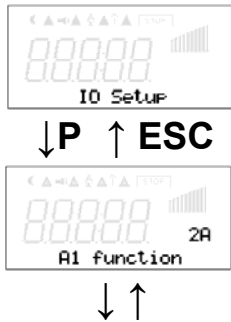

The following functions can be assigned to the output

| Function | description  |
|----------|--|
| OFF      | no Function  |
| 1 A      | Constant voltage +10 V ( <b>factory setting</b> for A2, out of 2.03)   |
| 2 A      | proportional modulation ( <b>Factory setting A1</b> )  |
| 3 A      | proportional input E1  |
| 4 A      | proportional input E2  |
| 5 A      | Group control  |
| 6 A      | Control output 2 increasing modulation at <u>actula value</u> >Set (cooling)<br>(only mode <b>2.03</b> temperature controller with additional functions) |
| 7 A      | Control output 2 increasing modulation at actual value <Set (Heating)<br>(only mode <b>2.03</b> temperature controller with additional functions)        |

Function 2 A proportional modulation

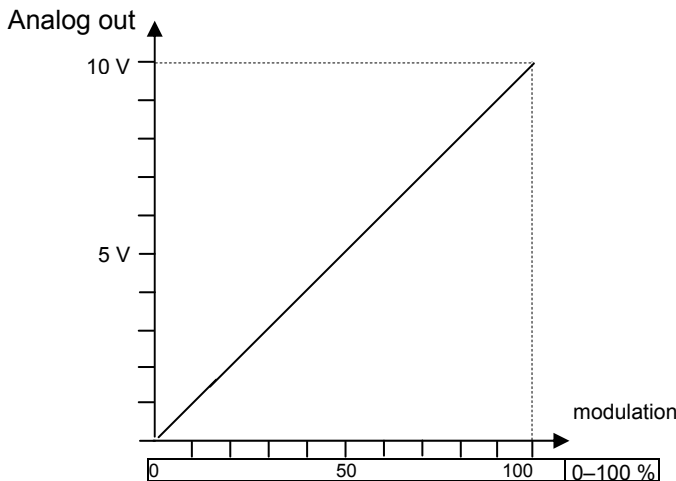

Idealized principle diagram

Function 3 A / 4 A proportional input signal

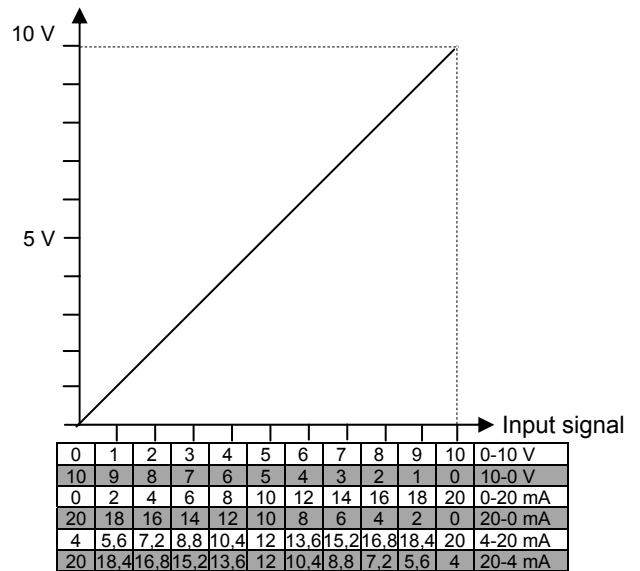

For activ sensors 0-10 V Signal proportional measuring range.  
 For passiv temperature sensors type TF.. (KTY10-6) proportional to -25 up to +80° C (↳ 1.303 Ω up to 2.886 Ω).

13.1.2 Adjustment analog output A1 und A2

With the attitudes **A1 min** or **A2 min** and **A1 max** or **A2 max** the characteristic of the output voltage can be adapted

Factory setting: **A1 min** or **A2 min** = 0 V, **A1 max** bzw. **A2 max** = 10 V

Setting range: **A1 min** or **A2 min** = 0-5 V, **A1 max** bzw. **A2 max** = 10-5 V

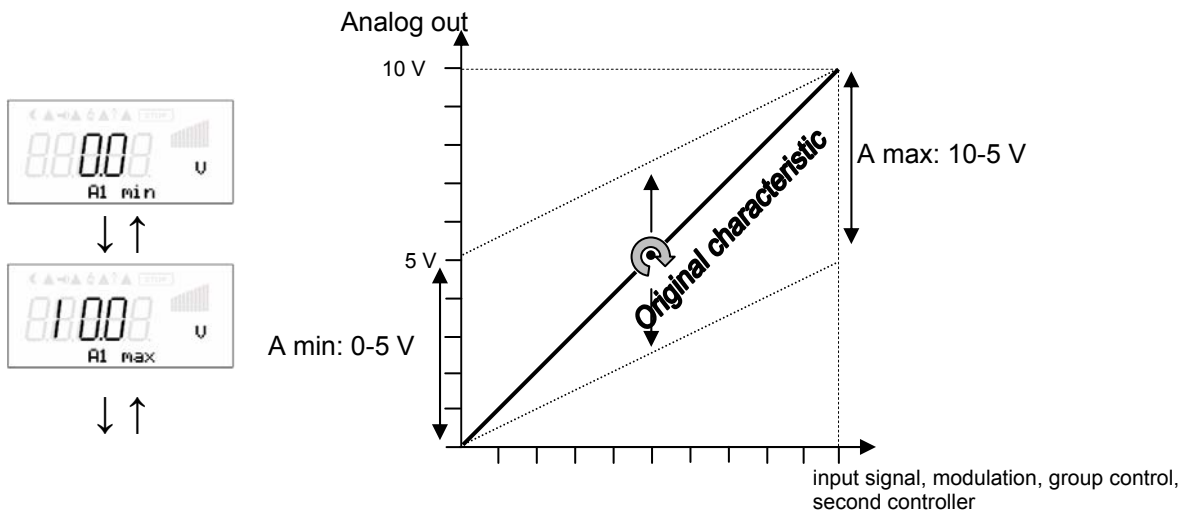

With the attitudes **A Inverting** the output voltage can be inverted

Factory setting OFF

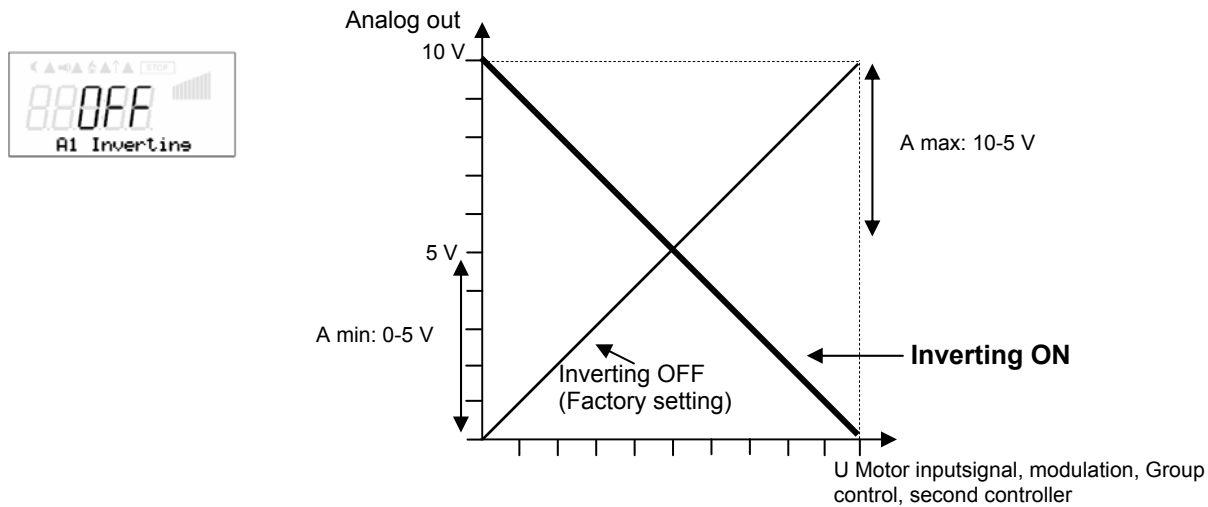

13.2 Functional overview of digital inputs D1 ... D5

The 5 digital inputs Digital IN 1 (D1) to Digital IN 5 (D5) can be allocated with various functions..  
Avoid the same function allocation for several Input in order to exclude undefined conditions.

Activation via floating contacts (a low voltage of approx. 24 V DC is connected).



**Never apply external voltage to the digital inputs!**

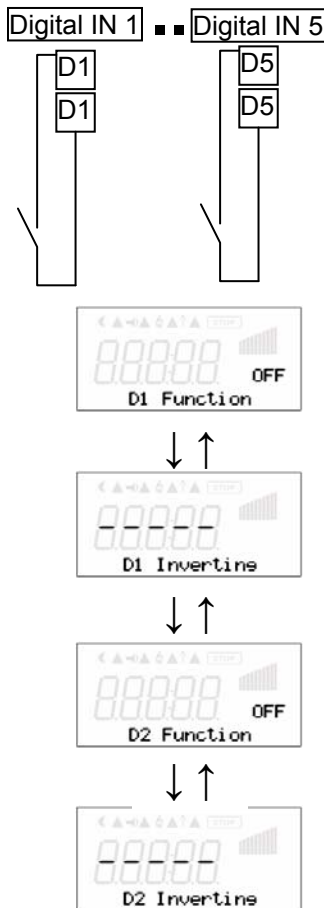

| Function  | description  |
|---|--|
| --  | no Function ( <b>factory setting</b> )<br>controller reacts neither to opened nor closed contact                                 |
| 1 D   | Enable (remote control) ON / OFF<br>Release ON / OFF   |
| 2 D   | External fault<br>connecting an external alarm indication  |
| 3 D   | Limit ON / OFF<br>Limitation of max. output voltage  |
| 4 D   | E1 / E2<br>Switch over between signal at Analog IN 1 (E1) and Analog IN 2 (E2)   |
| For mode speed controller <b>1.01</b>             |  |
| 5 D   | Set Intern 1 / 2<br>Switch over between 2 adjusted settings at the controller  |
| 6 D   | Intern / Extern<br>Switch over setting at the controller / external signal   |
| For modes as controller (higher <b>2.01</b> ....) |  |
| 5 D   | Setpoint 1 / 2<br>Switch over between 2 Setpoints (e. g. day- / night operation)   |
| 6 D   | Intern / Extern<br>Switch over between setting at the controller or external signal  |
| 7 D   | automatic control / speed manual internal (menu Speed manual)<br>switch over between automatic control and Speed manual          |
| 8 D   | Switch over between ON: ActualVal>Set =n+ and OFF: Actual>Set=n-<br>Reverse action of control function (e. g. Heating / Cooling) |

**Example:**  
Programming D1 (Digital IN 1) for enable controller by floating contact  
**Function 1D**

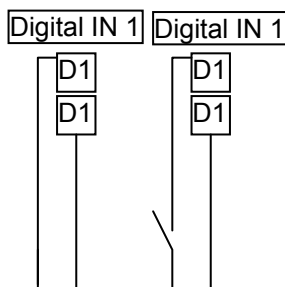
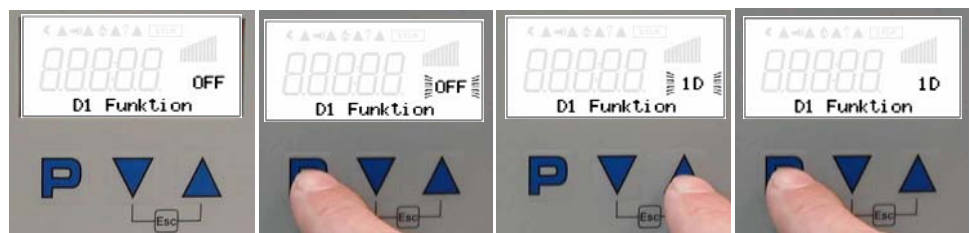

device ON    device OFF

D1 ..D5 Inverting

If D1 or D2 was allocated with a function, the device works factory preset with a non-inverted input **D Inverting OFF**  
Not inverted

Device ON with closed contact, device OFF with open contact on terminal D1-D1 (the other way around with inversion – i.e., device OFF with closed contact)

as long as no allocation is carried out: Display: ----

**13.2.1 Enable ON / OFF Funktion 1D**

Remote ON / OFF (electronic disconnection) contact free of potential, operation of the device is still possible after pressing the "ESC" hotkey combination in switched-off condition. Signal- in and outputs remain active  
 A programmed operating indicator relay (factory set K1 function 1K) reports the switch-off.  
 A programmed alarm relay (factory set K2 function 2 K) does not report the switch-off.



**No disconnection (isolation) when turned off, in accordance with VBG4 §6.**

Display **STOP** for switch off by remote switch at digital input e. g. Digital IN 1 = D1-D1

Controller ON for closed contact

**D1 Inverting** **OFF** D1-D1 bridged =controller ON

Controller ON with opened kontakt

**D1 Inverting** **ON** D1-D1 open = controller ON

**13.2.2 External fault Funktion 2D**

Connecting an external alarm indication (via floating contact).



The device continues to work unchanged during an external indication to the digital input; the alarm symbol appears in the display. This indication can be issued via the relay contacts (K1, K2) (☞ IO Setup function K1, K2).

Indication during closed contact (factory preset) **D1 Inverting** **OFF**

Indication during opened contact **D1 Inverting** **ON**

**13.2.3 Limit ON / OFF Funktion 3D**

The value for **Limit** adjusted in the Controller Setup, is activated over a digital input („Digital IN 1“ = D1-D5 or Timer function activates).

**Limit** value = max. possible modulation (e.g. speed reduction during night operation by time switch)

contact at digital inputs e.g. Digital IN 1 = D1-D1

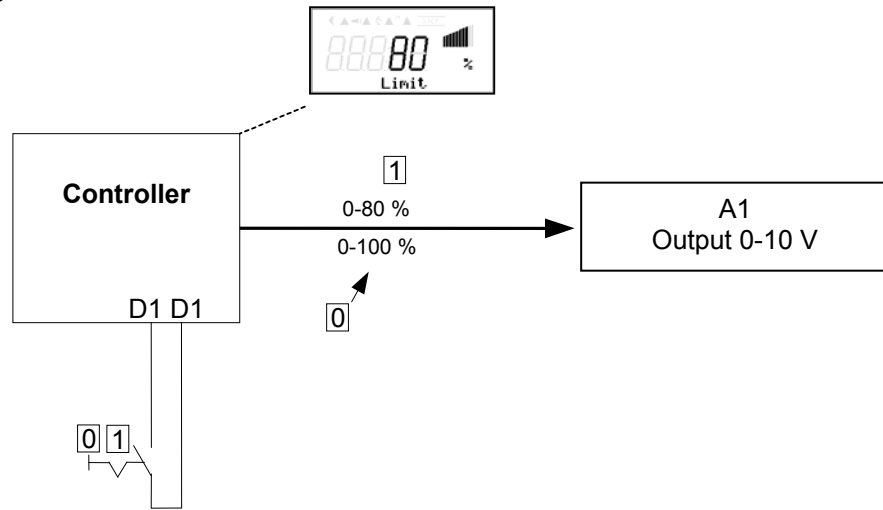

Limit ON (limitation activ) at closed contact (factory setting)

**D1 Inverting** **OFF**

Limit ON (limitation activ) at opened contact

**D1 Inverting** **ON**

**13.2.4 Switch over E1 / E2 Funktion 4D**

Switch over between input signal 1 (at Analog IN 1 terminal E1) and input signal 2 (an Analog IN terminal E2)

contact at digital input e. g. Digital IN 1 = D1-D1

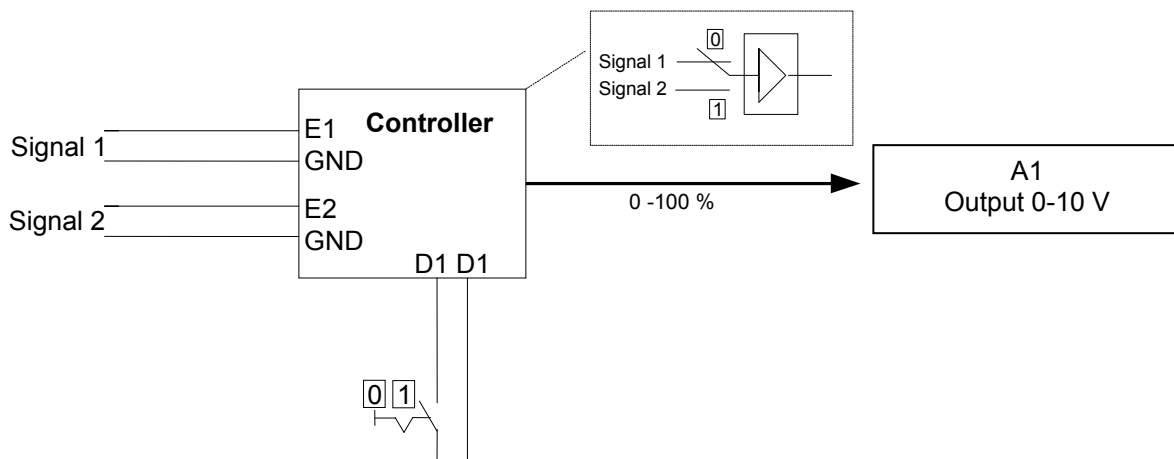

Signal from (E1) at opened contact ↔ Signal from “E2“ at closed contact

**D1 Inverting** **OFF**

Signal from (E1) at closed contact ↔ Signal from “E2“ at opened contact

**D1 Inverting** **ON**

13.2.5 Set Intern 1 / Set Intern 2 or. Setpoint 1/2 **Function 5D**

- ◆ **Switch over between Set Intern 1 and Set Intern 2** (for speed controller **1.01**)  
 Operation with "Internal default 2" is signaled by the moon symbol for reduced operation.

"Set external 1" under settings must be programmed to OFF.

contact at digital input e. g. Digital IN 1 = D1-D1

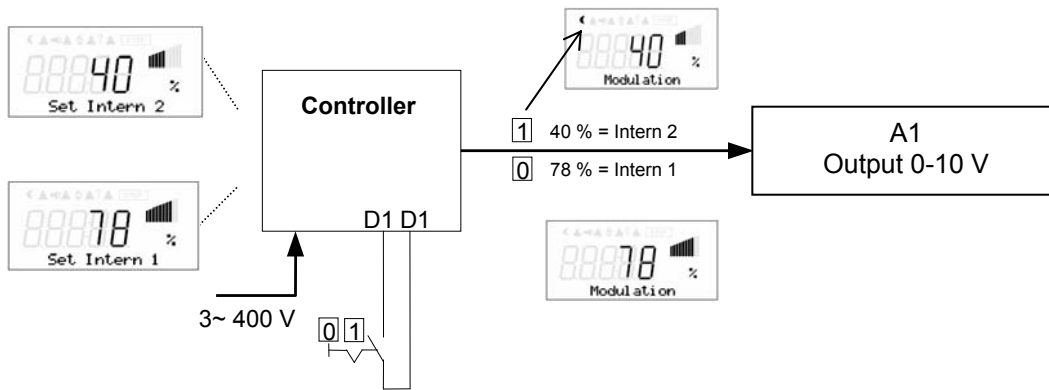

Set Intern 1 at opened contact ↔ Set Intern 2 at closed contact

**D1 Inverting**  OFF

Set Intern 1 at closed contact ↔ Set Intern 2 at closed contact

**D1 Inverting**  ON

- ◆ **Switch over between Setpoint 1 and Setpoint 2** (for modes as controller higher **2.01**)  
 operation with „Setpoint 2“ is signaled by the moon symbol for reduced operation.

contact at digital input e. g. Digital IN 1 = D1-D1

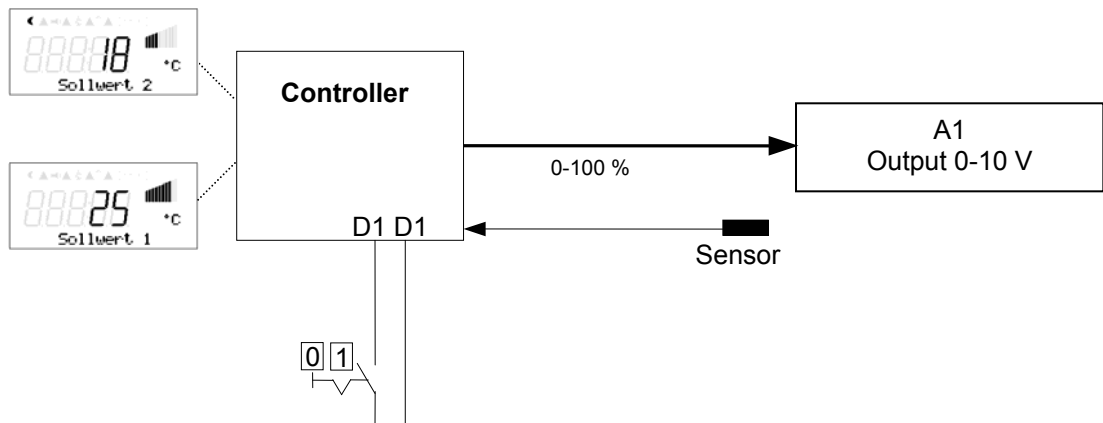

Setpoint 1 = 18° C at opened contact ↔ Setpoint 2 = 25° C at closed contact

**D1 Inverting**  OFF

Setpoint 1 = 18° C at closed contact ↔ Setpoint 2 = 25° C at opened contact

**D1 Inverting**  ON



13.2.6 Intern / Extern **Function 6D**

◆ **Switch over between Set Intern and Set Extern** (for mode speed controller **1.01**)

“Set external 1” under settings must be programmed to OFF contact at digital input e. g. Digital IN 1 = D1-D1

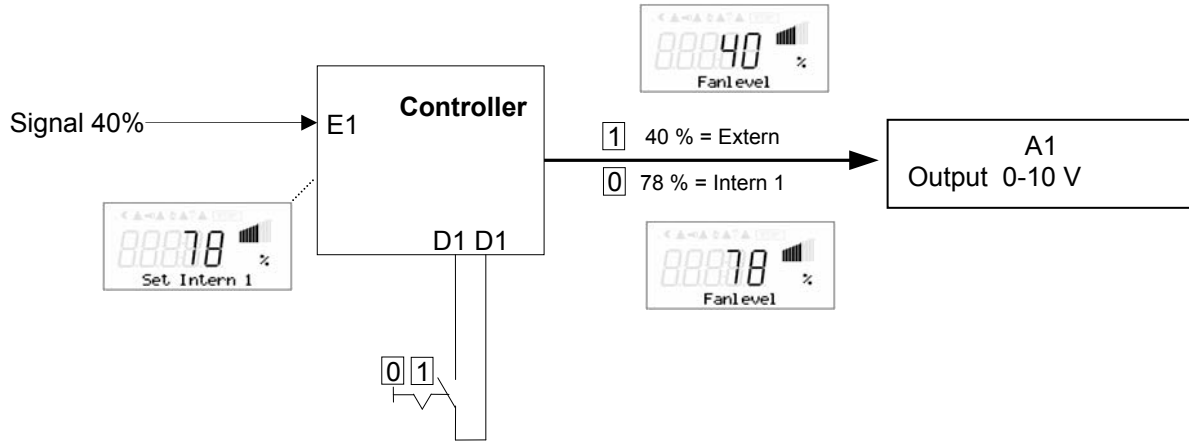

Set Intern 1 at opened kontakt ↔ Set Extern at closed contact **D1 Inverting** **OFF**

Set Intern 1 at closed kontakt ↔ Set Extern at opened contact **D1 Inverting** **ON**

◆ **Switch over between aktiv setting at the unit and external Signal** (for mode controller higher **2.01**)

Contact at digital input e. g. Digital IN 1 = D1-D1

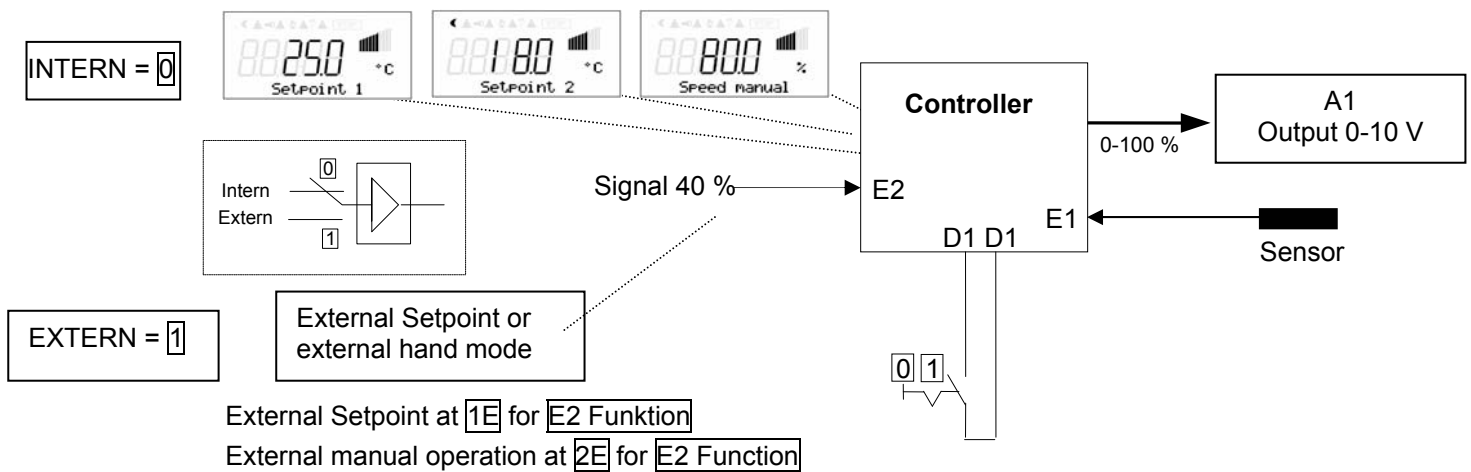

Setting at the unit at opened contact ↔ Signal Extern at closed contact **D1 Inverting** **OFF**

Setting at the unit at closed contact ↔ Signal Extern at opened contact **D1 Inverting** **ON**

**13.2.7 Automatic control / speed manual internal (Menu Speed maunal) Funktion 7D**

Switch over between automatic control to set target value (depending on the activation: Setpoint 1, Setpoint 2, Setpoint external) and the default for manual operation set at the device.

Contact at digital input e. g. Digital IN 1 = D1-D1

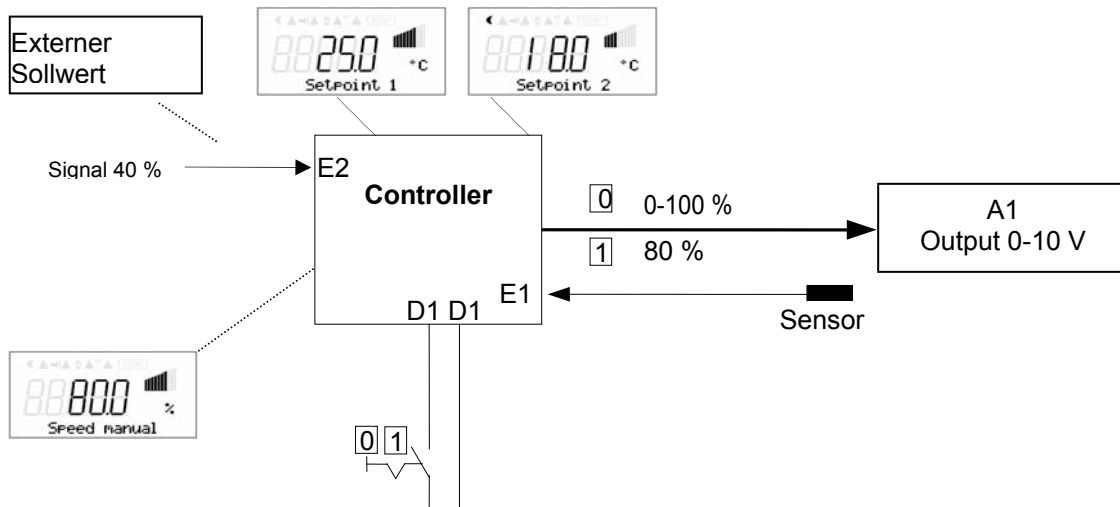

Automatic control at opened contact ↔ manual operation at closed contact

D1 Inverting  OFF

Automatic control at closed contact ↔ manual operation at opened contact

D1 Invertierung  ON

**13.2.8 Reverse action of control function actual value>Set = n+ or actual value>Set = n- Funktion 8D**

Switchover between: Increasing modulation during increasing actual-value and increasing modulation during sinking actual-value.

The factory presets for the “Control function“ are dependent on the selected mode of operation (☞ Controller Setup → reverse operation of the control function.)

When switching over via a digital input, the device works with the opposite function than the one set there!

Example: Actual value>Set = n+ (increasing modulation during increasingg actual value)

kontakt at digital input e. g. Digital IN 1 = D1-D1

Setting in Controller Setup

kontakt at digital input e. g. Digital IN 1 = D1-D1

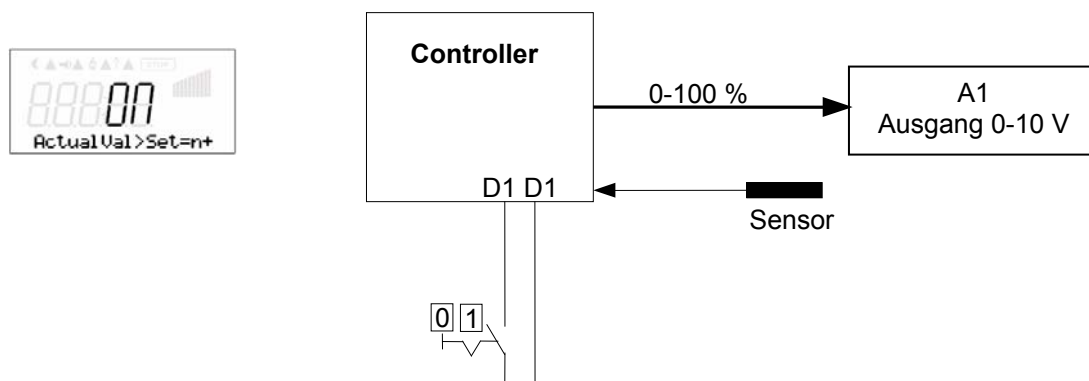

actual Value>Set = n+ at opened contact ↔ actual > Set = n- at closed kontakt

D1 Inverting  OFF

actual Value>Set = n+ at closed contact ↔ actual > Setl = n- at opened contact

D1 Inverting  ON

13.3 Inverting analog inputs E1 and E2

After programming the signal or sensor type, an inversion of the inputs can be carried out.



Factory setting for Inverting inputs = "OFF" (if input activated )  
(signal: 0-10 V, 0-20 mA, 4-20 mA)

For activation using inverted default signals or sensors with inverted output signals proportional to the measurement range, switch inverting to "ON"  
(Signal: 10-0 V, 20-0 mA, 20-4 mA)

Ziehl-Abegg sensors generally do not work with inverted output signals (i.e., these are not suitable for an inverted evaluation)

e. g.:

|         |         |              |          |
|---------|---------|--------------|----------|
| DSG200  | 0-10 V  | proportional | 0-200 Pa |
| MAL1    | 0-10 V  | proportional | 0-1 m/s  |
| DSF2-25 | 4-20 mA | proportional | 2-25 bar |
| MBG-30I | 4-20 mA | proportional | 0-30 bar |

In sensors with inverted outputs, 0 V or 4 mA must correspond to the final value of the measurement range.

e. g. pressure sensor 10-0 V                      proportional                      0-200 Pa

example:  
mode **1.01** speed controller  
setting by external signal

|           |     |
|-----------|-----|
| Inverting | OFF |
| Inverting | ON  |

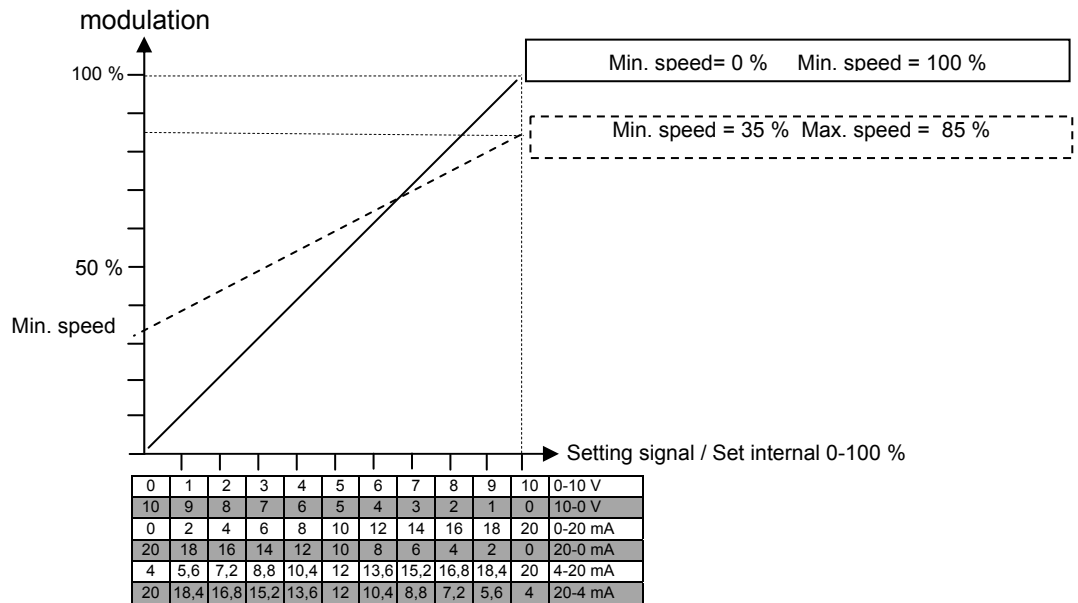

Idealized principle diagram

13.4 Function and inverting for relay outputs K1 and K2

Various functions can be allocated to the relay outputs K1 and K2  
 In case of the same function allocation for K1 and K2, these work parallel.

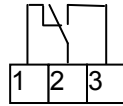

K1

Max. contact rating  
5 A / 250 V AC

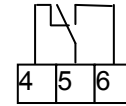

K2

1 = de-energized, terminals 2-3 bridged  
 0 = energized, terminals 1-2 bridged

1 = energized, bridged 5-6 bridged  
 0 = de-energized, bridged 4-5 bridged



| Function  | description  |
|---|--|
| --  | no Function<br>Relays remain always de-energized   |
| 1 K   | Operating indication ( <b>factory setting for K1</b> )<br>Operation without fault, reports enable ON / OFF   |
| 2 K   | Fault indication ( <b>factory setting for K2</b> )<br>At controller fault, Sensor fault dependent on programming, external fault at digital input      |
| 3 K   | External fault separate<br>With message at digital input (factory setting if terminals bridged)  |
| 4 K   | Limit modulation<br>when over or falling below limits for modulation   |
| 5 K   | Limit E1<br>when over or falling below limits for input signal E1  |
| 6 K   | Limit E2<br>when over or falling below limits for input signal E2  |
| For modes as controller (higher <b>2.01</b> ....)                                   |  |
| 7 K   | Setpoint Offset<br>Deviation between actual value and setpoint to high   |
| 8 K   | Group control<br>Switching on fans depending on modulation   |
| For modes as temperature controller with additional functions ( <b>2.03</b> ) ....) |  |
| 9 K   | Heating function<br>Switch ON point: temperature = Setpoint +/- Offset<br>Switch OFF point: Temperature around hysteresis <u>over</u> switch ON point  |
| 10 K  | Cooling function<br>Switch ON point: temperature = Setpoint +/- Offset<br>Switch OFF point: Temperature around hysteresis <u>below</u> switch ON point |

K1 / K2 Inverting

The factory preset is the inversion of relay K1 and K2 to „OFF“ (if a function has been programmed).  
 Switch to „ON“ for inversion (switch-time response depends on the allocated function). Fundamentally, the relays can only become operative if the electronics' voltage supply is functioning.

| Function | Controller status                                     | K1 / K2 Inverting |    |
|----------|---|-------------------|----|
|          |   | OFF               | ON |
| 1 K      | Operation without fault, line supply okay             | 1                 | 0  |
| 2 K      | Fault with indication by relay                        | 0                 | 1  |
| 3 K      | Ext. Fault at digital input for external fault        | 1                 | 0  |
| 4 K      | when over or falling below limits for modulation      | 1                 | 0  |
| 5 K      | when over or falling below limits for input signal E1 | 1                 | 0  |
| 6 K      | when over or falling below limits for input signal E2 | 1                 | 0  |
| 7 K      | setpoint deviation to high                            | 1                 | 0  |
| 8 K      | Switching on second group                             | 1                 | 0  |

### 13.5 Network for several devices by MODBUS

#### 13.5.1 MODBUS - RTU (Remote terminal unit)

It is possible to network several devices with each other. .

The device uses the MODBUS-RTU as the protocol for the RS-485 interface. The communications parameters are permanently set to 19200 baud, 8 data bits, EVEN parity, 1 stopbit, (8E1).

A maximum of 247 stations can be connected with each other. The device address (Device-ID) is factory set to the highest available MODBUS address: **247**

This address is reserved for operation with an external terminal model A-XG.. and should not be occupied with anything else.

The addresses of the individual units must be continuously numbered beginning with „1“. No address may be allocated twice.

MODBUS address adjustable from 1-247

Address 247 = preprogrammed for an external terminal



When using an external AXG.. terminal, the interface is assigned and can not be employed for anything else

#### 13.5.2 External display

The device uses MODBUS as the protocol for data exchange with an external AXG... display. During this, the external display is the MODBUS master. In this case, the interface is occupied and cannot be utilized for anything else.

The external display uses the **function code 105** (User Code) for the data exchange. This function code should therefore be avoided in a MODBUS system with other stations.

#### 13.5.3 Reading and writing parameters

The device supports reading and writing processes for MODBUS Holding Registers (3). The start address is 1; the number of registers depends on the device. If the allowable start address or number is exceeded, the device answers with an exception code. The description of the register is device dependent and can be requested from Ziehl-Abegg service for the device/version concerned.

14. Limits

14.1 Limit indication depending on modulation



following functions can be allocated to the limit indication

| Function | description   |
|----------|---|
| OFF      | No function   |
| 1 L      | Indication with the centralized fault of a programmed relay (IO allocation function <b>2K</b> ) warning symbol in display, "AL" code in events memory |
| 2 L      | Is merely displayed in the events menu as message "msg"   |

In the IO setup, a separate relay can be allocated independent of these settings.

If the modulation exceeds the set "Level max" value, this is reported until the set value "Level min" has been undercut. The indication is delayed by the time set in "Display delay".

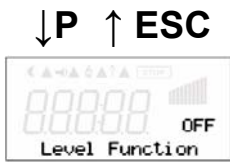

Time delay exceeding "Level max." Up to indication by relay and alarm symbol.  
 Factory setting 2 Seconds  
 setting range 0-120 Seconds

Example indication by relay K1:

**not inverted**

IO Setup → K1 Function: **4K**  
 IO Setup → K1 Inverting: „OFF“

**inverted**

IO Setup → K1 Function: **4K**  
 IO Setup → K1 Inverting: „ON“

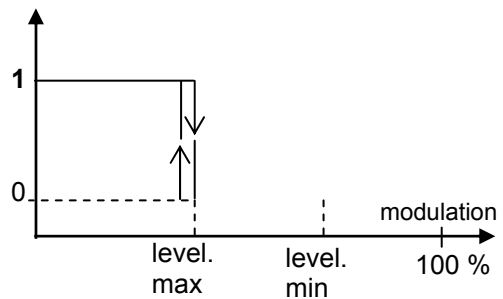
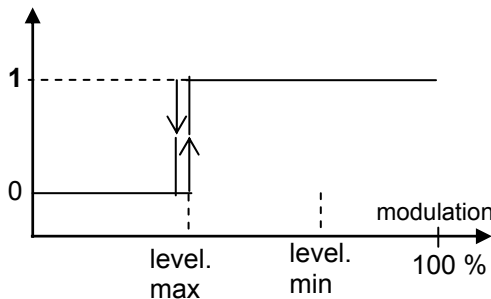
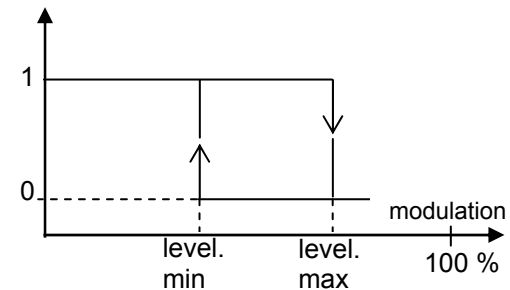
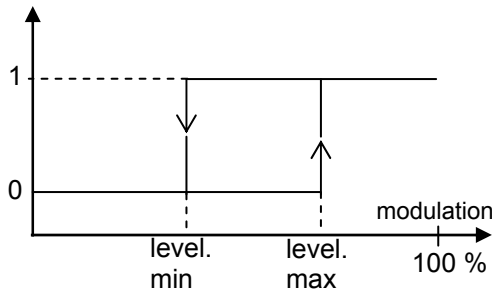

If „Display min“ is **higher** than „Display max“, the „Display max.“ switching point is without hysteresis!

14.2 Limit indication depending on setting or sensor signal

following functions can be allocated to the limit indication:



| Function | description   |
|----------|---|
| OFF      | No function   |
| 1 L      | Indication with the centralized fault of a programmed relay (IO allocation function 2K) warning symbol in display, "AL" code in events memory |
| 2 L      | Is merely displayed in the events menu as message "msg"   |

In the IO setup, a separate relay can be allocated independent of these settings

Both values for E1 („E1 min“ and „E1 max“) can be set independent of each other and act on a relay together if correspondingly programmed. If a function is activated or if a relay is allocated, both settings (min and max) are initially at OFF. Work can be carried out with one as well as with both limit indicators.

The same setting applies to E2 min and E2 max; described below for E1



**Undercutting the signal („E1 min“)**  
If the signal undercuts the set value „E1 min“, this is reported until the set value (plus adjustable hysteresis) has been exceeded once again.



**Exceeding the signal („E1 max“)**  
If the signal exceeds the set value „E1 max“, this is reported until the set value (minus hysteresis) has been undercut once again.



**Hysteresis adjustment in the unit of measure of the programmed input signal**



**Time delay during alarms**  
Factory preset 2-seconds, adjustment range 0-120 seconds



Always adjust the value for the maximum input signal higher than the value for the minimum input signal! E1 max. > E1 min!

**Example for a limit indication of default signal or sensor signal to Analog IN 1**

(Terminal E1 and GND) alarm via relay K1 (non-inverted) IO Setup → K1 function: „5 K“ = limit indicators E1

Settings: E1 max: 80 % / E1 min: OFF / switching hysteresis 5 % (from 100 %)

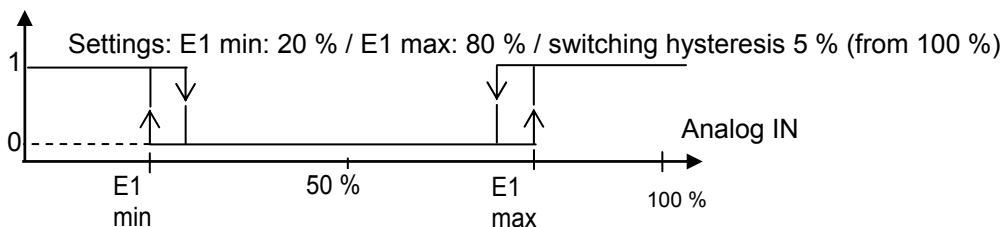
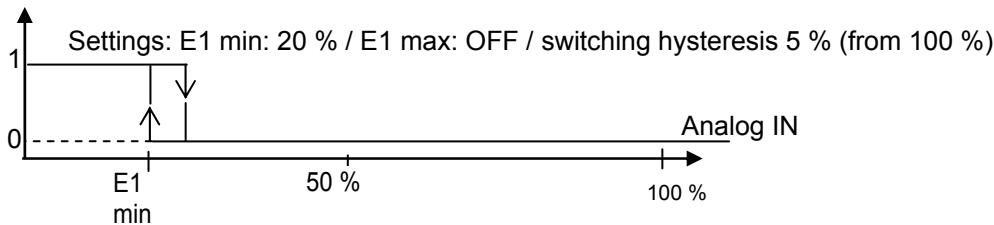
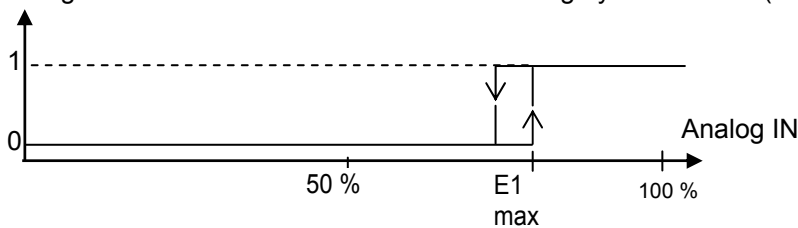

14.3 Limit indication depending on offset to Setpoint

In operating modes as a controller (via 2.01), two limit indicators can be carried out based on the set target value (Setpoint) and measured actual value (on E1).

The following functions can be allocated to this limit indicator



| Function | Description   |
|----------|---|
| OFF      | No function   |
| 1 L      | Indication with the centralized fault of a programmed relay (IO allocation function 2K) warning symbol in display, "AL" code in events memory |
| 2 L      | Is merely displayed in the events menu as message "msg"   |

In the IO setup, a separate relay can be allocated independent of these settings.

Both values for Offset 1 and Offset 2 can be set independent of each other and act on a relay together if correspondingly programmed. If a function is activated or if a relay is allocated both settings (Offset 1 and Offset 2) are initially at OFF. Work can be carried out with one as well as with both limit indicators.



**Offset 1** for alarm in case of an **exceeding of the max. deviation** between actual and target  
 SwitchON point: actual value = Setpoint +/- offset  
 SwitchOFF point: Actual value by hysteresis under the switch-on point.



**Offset 2** for alarm in case of an **undercutting of the max. deviation** between actual and target  
 SwitchON point: actual value = target value +/- offset  
 SwitchOFF point: Actual value by hysteresis over the switch-on point.



Hysteresis switch-on point: In temperature regulation ±10 K, otherwise sensors 10 % of measurement range.



Time delay until indication through relay and alarm symbol. Factory preset 2 seconds, adjustment range 0-120 sec

Example for temperature regulation; for other modes of operation settings in corresponding sensor unit.

Offset 1 for alarm during exceeding

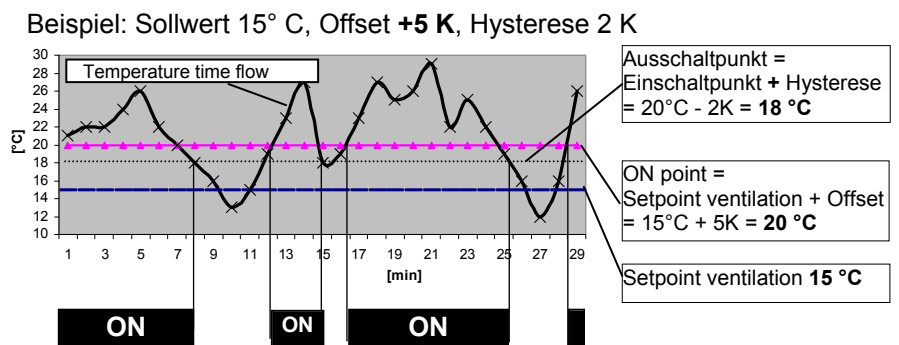

Offset 2 for alarm during undercutting

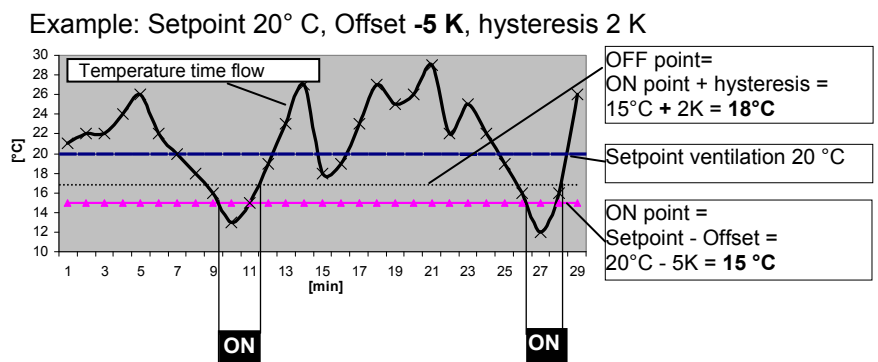



**15. Timer (timer)**

The device has a real-time clock. The clock is buffered and has a 2-3 day reserve. The time and date must be set during start-up operation and when using the real-time clock. The device calculates the weekday based on the date.

**15.1 Setting the time and date**



↓ **P** ↑ **ESC**



„Press the „P button“ and, using the UP and DOWN keys, set the hours. Press the „P button“ to save. The minutes indicator now flashes and can be set using the UP / DOWN keys. Press the „P button“ once more to conclude. The time has now been stored. This procedure only takes a moment. Afterwards, the new time appears in the display.

↓ ↑

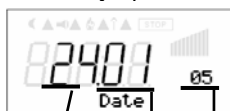

To set the date follow the same method as for „Time“. The date setting consists of DAY, MONTH, and YEAR

day / month / year

**15.2 Automatic summer/winter time**

The automatic summer/winter time is factory set to „OFF“, i.e. switched off.

When the automatic summer/winter timer is set to = „ON“, the device automatically switches between daylight savings time and standard time.



Automatic swicht over between summer time and winter time

**15.3 Timer function**

In principle, the timer function acts like one digital switch input. Thus, the same functions can be assigned to the timer switch as the digital inputs, „D1“, „D2“..

A summary of the timer functions (example IO Setup / Function description **1D**.**8D**) then corresponds to Timer „On“ with function 1D a closed contact with function **2D**.**8D** a closed contact (OFF during inversion).

| Function  | description  | Timer ON =       |
|---|--|------------------|
| --  | no function (factory setting)  |                  |
| 1 D   | Enable (remote control) ON / OFF   | Device OFF       |
| 2 D   | External fault   | fault            |
| 3 D   | Limit ON / OFF Limitation of max. output voltage   | Limit ON         |
| 4 D   | E1 / E2 Switch over between signal at Analog IN 1 (E1) and Analog IN 2 (E2)  | Signal at E2     |
| For mode speed controller <b>1.01</b>             |  |                  |
| 5 D   | Set Intern 1 / 2 Switch over between 2 adjusted settings at the controller   | Set intern 2     |
| 6 D   | Intern / Extern Switch over setting at the controller / external signal  | External signal  |
| For modes as controller (higher <b>2.01</b> ....) |  |                  |
| 5 D   | Setpoint 1 / 2 Switch over between 2 Setpoints (e. g. day- / night operation)  | Setpoint 2       |
| 6 D   | Intern / Extern Switch over between setting at the controller or external signal   | External signal  |
| 7 D   | switch over between automatic control and Speed manual   | Setting manual   |
| 8 D   | Switch over between ON: ActualVal>Set =n+ and OFF: Actual>Set=n-<br>Reverse action of control function (e. g. Heating / Cooling) | Reverse Standard |

**Example:**  
Programming limitation for output voltage („Limit ON / OFF“)

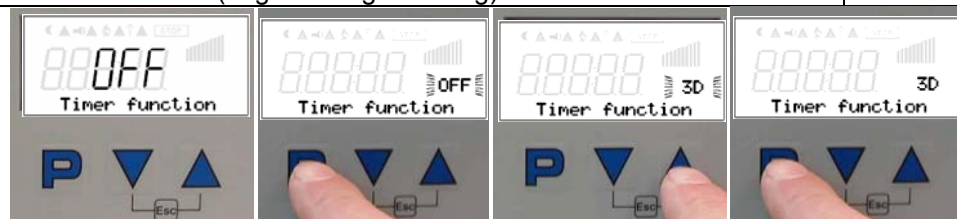

15.4 Enter switching times

Two switching times can be entered for the same function (e.g. 3D = Limit) for each weekday. The menu items are repeated for each weekday with two on- and off-times each. Switching times are not preprogrammed at the factory.

In order to make configuration easier, the same switching times can be made for several days in a block. To prevent unwanted switching times from arising, all should be deleted before programming. To do this, select the block **Mo - Su** and deactivate all 4 switching times.

Be sure to delete all switching times before carrying out complete new settings.

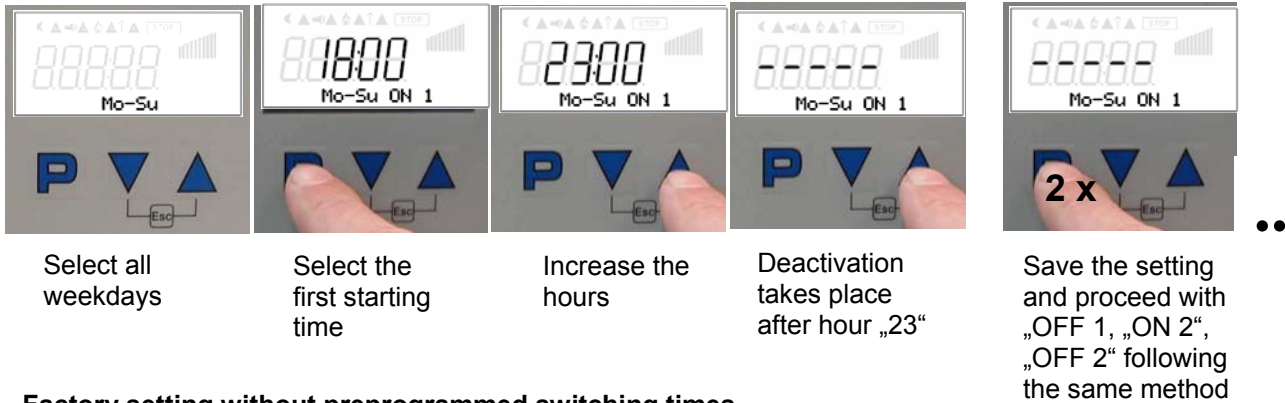

◆ Factory setting without preprogrammed switching times

| Mo - Su |       |       |       |       |       |       |       |       |         |       |       |       |       |
|---------|-------|-------|-------|-------|-------|-------|-------|-------|---------|-------|-------|-------|-------|
| Mo - Fr |       |       |       |       |       |       |       |       | Sa - Su |       |       |       |       |
| Mo      | Tu    | We    | Th    | Fr    | Sa    | Su    |       |       |         |       |       |       |       |
| ON1     | --:-- | ON 1  | --:-- | ON 1  | --:-- | ON 1  | --:-- | ON 1  | --:--   | ON 1  | --:-- | ON 1  | --:-- |
| OFF1    | --:-- | OFF 1 | --:-- | OFF 1 | --:-- | OFF 1 | --:-- | OFF 1 | --:--   | OFF 1 | --:-- | OFF 1 | --:-- |
| ON 2    | --:-- | ON 2  | --:-- | ON 2  | --:-- | ON 2  | --:-- | ON 2  | --:--   | ON 2  | --:-- | ON2   | --:-- |
| OFF 2   | --:-- | OFF 2 | --:-- | OFF 2 | --:-- | OFF 2 | --:-- | OFF 2 | --:--   | OFF 2 | --:-- | OFF 2 | --:-- |

◆ Example 1: Every day at 8 am ON and at 6 pm OFF

| Mo - Su |       |       |       |       |       |       |       |       |       |       |       |       |       |
|---------|-------|-------|-------|-------|-------|-------|-------|-------|-------|-------|-------|-------|-------|
| EIN1    | 08:00 | EIN 1 | 08:00 | EIN 1 | 08:00 | EIN 1 | 08:00 | EIN 1 | 08:00 | EIN 1 | 08:00 | EIN 1 | 08:00 |
| OFF1    | 18:00 | OFF1  | 18:00 | OFF1  | 18:00 | OFF1  | 18:00 | OFF1  | 18:00 | OFF1  | 18:00 | OFF1  | 18:00 |
| ON 2    | --:-- | ON 2  | --:-- | ON 2  | --:-- | ON 2  | --:-- | ON 2  | --:-- | ON 2  | --:-- | ON 2  | --:-- |
| OFF2    | --:-- | OFF2  | --:-- | OFF2  | --:-- | OFF2  | --:-- | OFF2  | --:-- | OFF2  | --:-- | OFF2  | --:-- |

◆ Example 2: Monday to Friday at 6 am ON at 8 am OFF and at 5 pm ON at 10 pm OFF

| Mo - Fr |       |      |       |      |       |      |       |      | Sa - Su |      |       |      |       |
|---------|-------|------|-------|------|-------|------|-------|------|---------|------|-------|------|-------|
| ON1     | 06:00 | ON1  | 06:00 | ON1  | 06:00 | ON1  | 06:00 | ON1  | 06:00   | ON1  | --:-- | ON1  | --:-- |
| OFF1    | 08:00 | OFF1 | 08:00 | OFF1 | 08:00 | OFF1 | 08:00 | OFF1 | 08:00   | OFF1 | --:-- | OFF1 | --:-- |
| ON2     | 17:00 | ON2  | 17:00 | ON2  | 17:00 | ON2  | 17:00 | ON2  | 17:00   | ON2  | --:-- | ON2  | --:-- |
| OFF2    | 22:00 | OFF2 | 22:00 | OFF2 | 22:00 | OFF2 | 22:00 | OFF2 | 22:00   | OFF2 | --:-- | OFF2 | --:-- |

◆ Example 3: Wednesday 6 pm ON and Thursday at 8 am OFF

| Mo   | Tu    | We   | Th    | Fr   | Sa    | Su   |       |      |       |      |       |      |       |
|------|-------|------|-------|------|-------|------|-------|------|-------|------|-------|------|-------|
| ON1  | --:-- | ON1  | 18:00 | ON1  | --:-- | ON1  | --:-- | ON1  | --:-- | ON1  | --:-- | ON1  | --:-- |
| OFF1 | --:-- | OFF1 | --:-- | OFF1 | 08:00 | OFF1 | --:-- | OFF1 | --:-- | OFF1 | --:-- | OFF1 | --:-- |
| ON2  | --:-- | ON2  | --:-- | ON2  | --:-- | ON2  | --:-- | ON2  | --:-- | ON2  | --:-- | ON2  | --:-- |
| OFF2 | --:-- | OFF2 | --:-- | OFF2 | --:-- | OFF2 | --:-- | OFF2 | --:-- | OFF2 | --:-- | OFF2 | --:-- |

◆ Free tables for entering individual timer settings

| Mo   | Tu | We   | Th | Fr   | Sa | Su   |  |      |  |      |  |      |  |
|------|----|------|----|------|----|------|--|------|--|------|--|------|--|
| ON1  |    | ON1  |    | ON1  |    | ON1  |  | ON1  |  | ON1  |  | ON1  |  |
| OFF1 |    | OFF1 |    | OFF1 |    | OFF1 |  | OFF1 |  | OFF1 |  | OFF1 |  |
| ON2  |    | ON2  |    | ON2  |    | ON2  |  | ON2  |  | ON2  |  | ON2  |  |
| OFF2 |    | OFF2 |    | OFF2 |    | OFF2 |  | OFF2 |  | OFF2 |  | OFF2 |  |

16. Diagnostics menu



The diagnostics menu supplies information about the momentary operating condition of the device. Under certain circumstances, conclusions can be drawn about possible malfunctions through these insights..



**Operation hours counter for Controller.**  
The time counting runs, as soon as mains voltage is connected (without fault). If events step on (motor fault, external fault, etc.), the period of operation is stored at this time.



**Operation hours counter for motor.**  
The time counting runs as soon as a modulation of the controller is present.



Signal height at analog input E1 (Analog IN 1)



Signal height at analog input E2 (Analog IN 2)



Status digital input 1 (Digital IN 1)  
OFF = terminals D1- D1 bridged ↔ ON = terminals D1-D1 not bridged



Status digital input 2 (Digital IN 2)  
OFF = terminals D2- D2 bridged ↔ ON = terminals D2-D2 not bridged



Status digital input (Digital IN 3)  
OFF = terminals D3- D3 bridged ↔ ON = terminals D3-D3 not bridged



Status digital input 4 (Digital IN 4)  
OFF = terminals D4- D4 bridged ↔ ON = terminals D4-D4 nicht gebrückt



Status digital input 5 (Digital IN 5)  
OFF = terminals D5- D5 bridged ↔ ON = terminals D5-D5 nicht gebrückt



Status timer function



OFF = relay K1 de-energized terminals 1-2 bridged  
ON = relay K1 energized = terminals 2-3 bridged



OFF = relay K2 de-energized terminals 4-5 bridged  
ON = relay K2 energized = terminals 5-6 bridged

17. Enclosure

17.1 Connection diagram

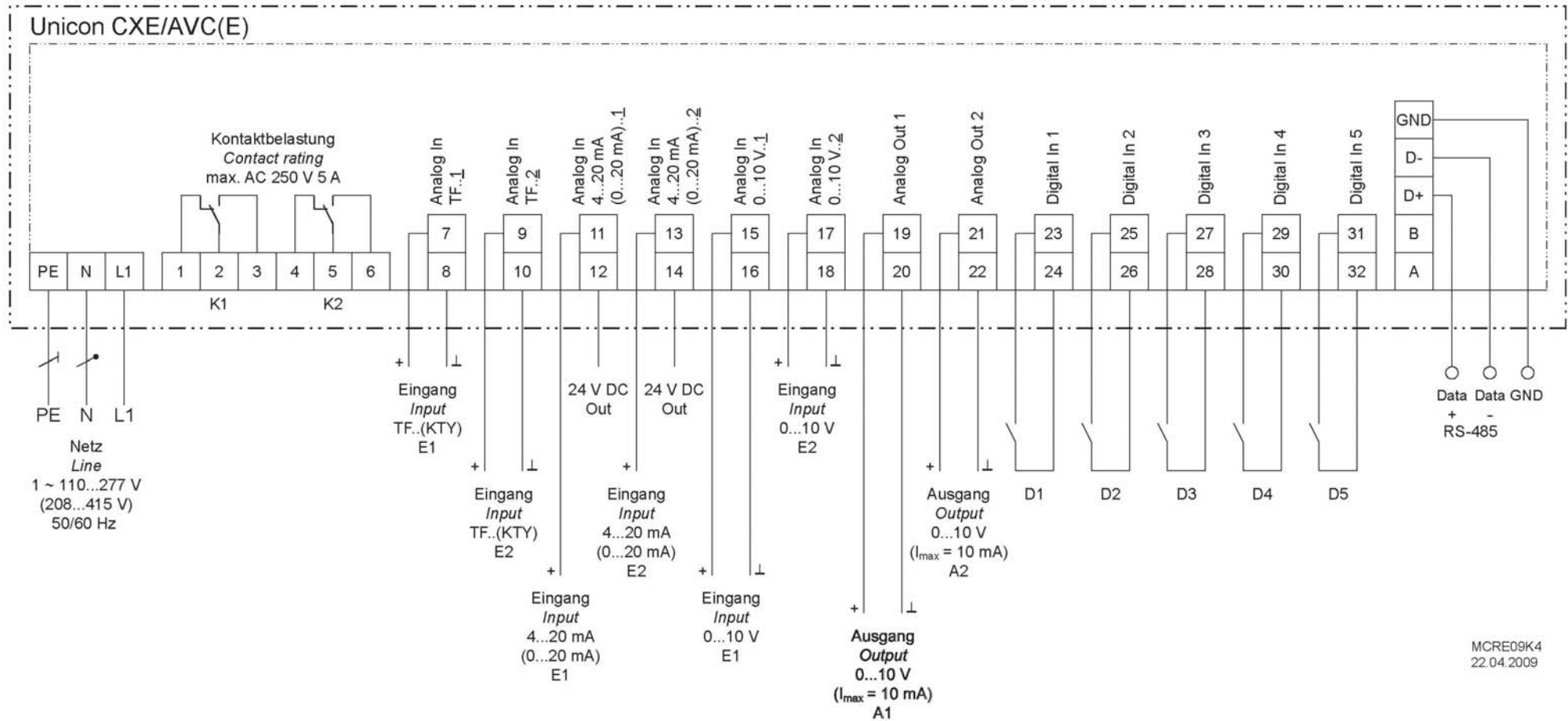

17.2 Dimension sheet

Wall housing IP54 CXE/AVC

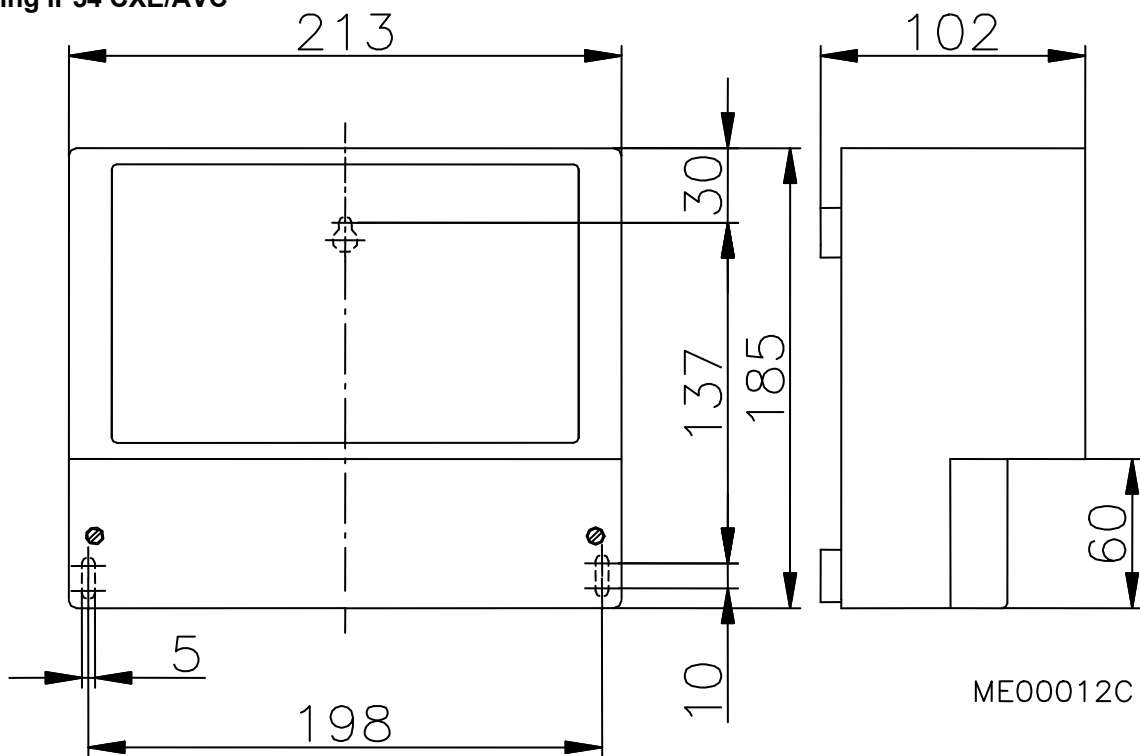

Installation into control panel CXE/AVCE

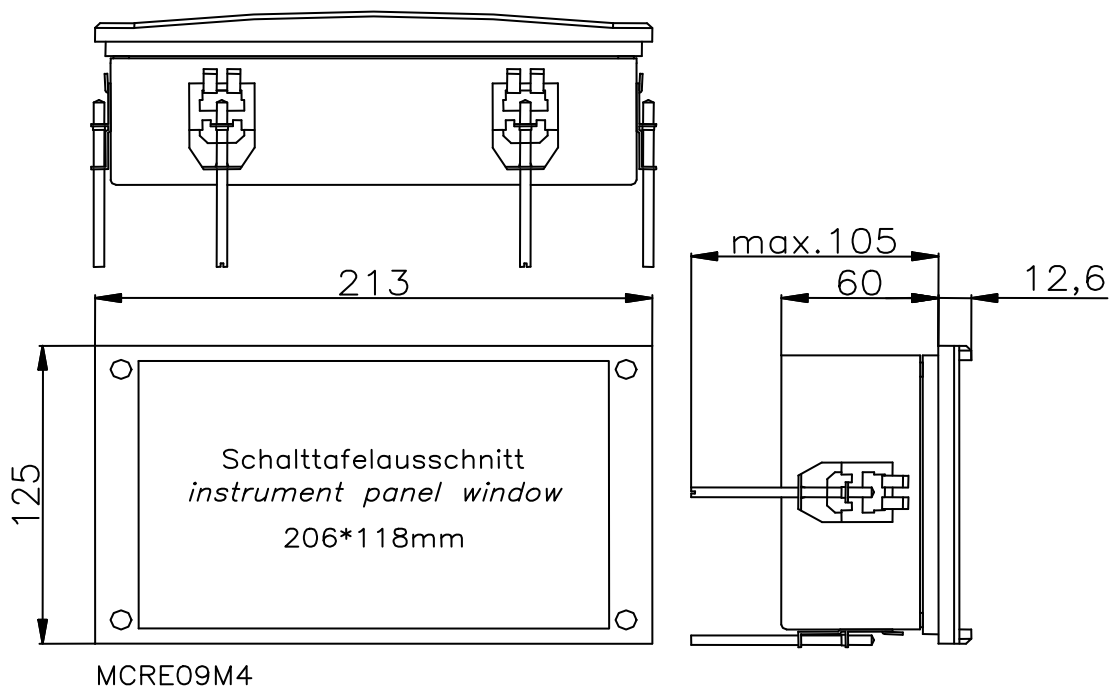

**18. Events**



The last 10 (0-9) events and malfunctions are stored in the „Events“ menu group (position „0“ = most recent event).

The device differentiates between 3 types of events:

1. Messages with code **Msg**

Message sensor fault for information if “Alarm Sensor” deactivated.

2. Alarms with code **AL**

Events during which the device automatically restarts operation or remains in operation after the cause of the malfunction has been remedied (e.g. externally-trunked centralized fault).

A momentary pending alarm or error message is indicated by a blinking indicator and appears alternately with the standard display.

Possible events and faults:

- **Factory setting** **Msg**  
Fault in Eprom  
controller works with defaults
- **Externe fault** **AL**  
Motor protection unit triggered (signal contact at digital input)
- **EEP Error** **AL**  
fault EEP EEP damaged  
controller works with defaults
- **EEP Corruption** **AL**  
data incorrectly. Controller runs with the read settings

With the "P" key can be switched between description of the message and the time when it happened.  
E.G. on place 3 which is past message "motor fault"

**Inquiry of the CONTROLLERS period of operation at the time of the message.**

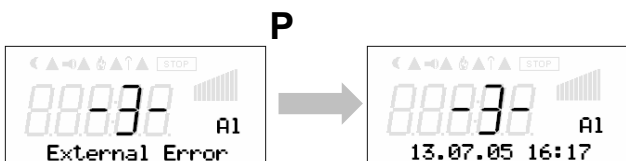

**19. Messages and trouble shooting**

A momentary pending alarm or error message is indicated by a blinking indicator and appears alternately with the standard display. In addition, it is signaled via the 3-internal LED's.



No Display

- line voltage available ? Unit switches OFF and automatically ON when the voltage has been restored
- check internal controller fuse)



Sensor fault

Interruption / short circuit in the sensor leads or sensor values measured are outside measuring range.  
(Controller setup Alarm Sensors = ON)



NO enable

Switch OFF by external contact  
(function 1D = enable programmed for Digital IN1/2 )



External fault

Alarm from external contact (e.g. motor protection unit STDT with auxiliary contact)



Limit indication actual minimum

Actual value below setting “Alarm Minimum”  
(Input E1)



Limit indication actual maximum

Actual value above setting “Alarm Maximum”  
(Input E1)

**20. Index**

|   |    |
|---|----|
| <b>A</b>                                |    |
| Address .....                           | 54 |
| Air velocity control .....              | 36 |
| Analog Output .....                     | 44 |
| Ausgang 0-10 V .....                    | 44 |
| Automatic summer/winter time .....      | 58 |
| Average calculation .....               | 17 |
| <b>C</b>                                |    |
| Connection diagram .....                | 61 |
| connection for input signal .....       | 10 |
| control function .....                  | 42 |
| controller action .....                 | 43 |
| Controller Setup .....                  | 40 |
| controller type .....                   | 43 |
| Cooling .....                           | 20 |
| cooling function .....                  | 18 |
| <b>D</b>                                |    |
| Date .....                              | 58 |
| Datenbus .....                          | 9  |
| D-component .....                       | 43 |
| Diagnostic .....                        | 60 |
| difference temperature .....            | 17 |
| digital inputs .....                    | 46 |
| Dimension sheet .....                   | 62 |
| <b>E</b>                                |    |
| Enable .....                            | 47 |
| Enter switching times .....             | 59 |
| Events .....                            | 63 |
| External setpoint .....                 | 10 |
| <b>H</b>                                |    |
| Heating .....                           | 20 |
| heating function .....                  | 18 |
| <b>I</b>                                |    |
| I-component .....                       | 43 |
| input resistance .....                  | 6  |
| Integration time .....                  | 43 |
| isolation .....                         | 47 |
| <b>K</b>                                |    |
| K-Factor .....                          | 32 |
| <b>L</b>                                |    |
| Limit .....                             | 41 |
| Limit .....                             | 48 |
| Limits .....                            | 55 |
| <b>M</b>                                |    |
| MAL1/10 .....                           | 36 |
| Menu group Info .....                   | 39 |
| Menu group Start .....                  | 39 |
| Messages .....                          | 63 |
| Minimum speed cut off .....             | 41 |
| MODBUS .....                            | 9  |
| Mode .....                              | 11 |
| mode of operation .....                 | 11 |
| <b>N</b>                                |    |
| Network .....                           | 54 |
| <b>O</b>                                |    |
| Outdoor installation .....              | 7  |
| Output 0-10 V .....                     | 44 |
| <b>P</b>                                |    |
| P-component .....                       | 43 |
| PID .....                               | 43 |
| PIN .....                               | 39 |
| PIN-Protection .....                    | 40 |
| Pressure Control Air Conditioning ..... | 28 |
| Pressure control for condensers .....   | 24 |
| Programming .....                       | 14 |
| <b>R</b>                                |    |
| refrigerant .....                       | 24 |
| Relay outputs .....                     | 53 |
| Reset .....                             | 39 |
| Reverse .....                           | 42 |
| RS-485 .....                            | 9  |
| <b>S</b>                                |    |
| save user settings .....                | 40 |
| Second group .....                      | 42 |
| Sensor Alarm ON / OFF .....             | 41 |
| sensor cable .....                      | 8  |
| Set Intern 2 .....                      | 49 |
| Set protection .....                    | 40 |
| Setpoint 2 .....                        | 49 |
| Setup .....                             | 44 |
| Signal connection .....                 | 8  |
| Speed controller .....                  | 14 |
| speed reduction .....                   | 48 |
| <b>T</b>                                |    |
| Technical data .....                    | 6  |
| Temperature control .....               | 16 |
| Time .....                              | 58 |
| Timer .....                             | 58 |
| Timer function .....                    | 58 |
| Trouble shooting .....                  | 63 |
| Two-wire-technology .....               | 8  |
| <b>V</b>                                |    |
| volume control .....                    | 32 |